

# **TURBO TANK**

## **Commercial Grade**

### **Portable HVACR Rinsing Sprayer**



Nu-Calgon Part No. 4778-0

- **High Velocity Portable HVAC Coil Sprayer**
- **Extremely Portable – NO MORE SEARCHING for a Water Connection**
- **Optimal 130PSI Water Pressure – Rinse Quickly and Safely**
- **Use with Water Only for Rinsing – Do Not Use with Chemicals**
- **High Capacity Lead Acid Rechargeable Battery**
- **Improved Brass Hardware for Commercial Grade Durability**
- **Perfect for Mini-Splits, Air Handlers, Condensers, and Rooftop Units**

# CONTENTS

<b>OPERATING INSTRUCTIONS.....</b>	<b>3</b>
<b>IMPORTANT SAFETY INSTRUCTIONS.....</b>	<b>3</b>
<b>WARNING TO REDUCE THE RISK OF INJURY.....</b>	<b>4</b>
<b>LIMITED WARRANTY.....</b>	<b>5</b>
<b>HOW TO OPERATE.....</b>	<b>8</b>
<b>AUTOMATIC SHUTOFF.....</b>	<b>9</b>
<b>GENERAL MAINTENANCE.....</b>	<b>10</b>
<b>STORING OF THE PORTABLE HVAC SPRAYER.....</b>	<b>11</b>
<b>FAQ's.....</b>	<b>12</b>

# CONGRATULATIONS!

Thank you for your purchase of Nu-Calgon's Turbo Tank Commercial Grade Portable HVACR Rinsing Sprayer. We have designed this product to make your daily HVACR maintenance work easier and quicker. No more searching for hard to access water connection or lugging around long water hoses. Designed to be used to rinse a small air cooled coil after a Nu-Calgon cleaner has been applied independently. We are very proud of this product and we hope that you are equally satisfied with the quality and performance.

Thank you for your support in choosing Nu-Calgon products!

## OPERATING INSTRUCTIONS

Please read these instructions and warnings carefully before using your Turbo Tank HVACR Rinsing Sprayer.

### **WARNING:**

Small parts may cause choking hazard.

## IMPORTANT SAFETY INSTRUCTIONS

When using the Turbo Tank HVACR Rinsing Sprayer, these basic precautions should always be followed:

1. DO NOT FILL THE TURBO TANK HVACR RINSING SPRAYER WITH ANY NU-CALGON COIL CLEANER OR OTHER LIQUID OTHER THAN CLEAN WATER. SERIOUS INJURY MAY OCCUR. ALSO CLEANERS CAN DAMAGE THE SPRAYER AND WILL VOID WARRANTY.
2. ALWAYS APPLY NU-CALGON COIL CLEANER SEPARATELY WITH AN AEROSOL CANISTER OR APPLY DILUTED CLEANER WITH ANOTHER SPRAYER. THE TURBO TANK HVACR RINSING SPRAYER IS MEANT TO BE A RINSING TOOL WITH CLEAN WATER.
3. STUDY THE PRODUCT THOROUGHLY BEFORE OPERATING IT. BE FAMILIAR WITH ITS OPERATING CONTROLS.
4. DO NOT OPERATE THE PRODUCT UNDER THE INFLUENCE OF ALCOHOL OR DRUGS.
5. DAMAGED HIGH PRESSURE HOSES CAN BURST AND CAN CAUSE A POTENTIALLY HAZARDOUS SITUATION AND OR INJURY. HIGH PRESSURE HOSES SHOULD NOT BE KINKED, CRUSHED, TWISTED, OR DAMAGED IN ANY WAY. SHOULD THIS OCCUR, REPLACE THE HIGH PRESSURE HOSE.
6. ONLY USE WATER BETWEEN 10°C to 40°C (40°F to 104°F).

# WARNING

## TO REDUCE THE RISK OF INJURY:

1. Do not leave the Turbo Tank HVACR Rinsing Sprayer when plugged in. Unplug from power port when not in use and before maintenance of the machine.
2. This is NOT a toy. Close attention is necessary when used near children.
3. Use only Nu-Calgon's recommended accessories and replacement parts. Do not use with a damaged cord or plug. Do not use the Turbo Tank HVACR Rinsing Sprayer if it is damaged, dropped into water, or when it is not working as it should.
4. Do not pull the cord, carry the unit by the cord, use the cord as handle, or pull the cord around sharp edges. Keep the cord away from heated surfaces.
5. Keep the nozzles free of obstructing objects. Do not use the Turbo Tank HVACR Rinsing Sprayer when the nozzle clogged; keep free of dust, lint, hair, and anything that may reduce flow.
6. Keep hair, loose clothing, fingers, and all body parts away from moving machine parts.
7. Do not use without the water filter in place.
8. Turn off all controls before unplugging.
9. Using improper voltage may result in damage to the motor and possible injury to the user. The proper voltage is listed on the cleaner plate.
10. Do not direct the water jet toward the unit itself, electrical parts, or towards other electrical equipment.
11. Do not alter the original diameter of the spray head nozzle.
12. DISCHARGE residual pressure before disconnecting the Turbo Tank HVACR Rinsing Sprayer hose.
13. Before using the Turbo Tank HVACR Rinsing Sprayer, CHECK that the screws are fully tightened and that there are no broken or worn parts.
14. **DO NOT USE with any chlorine based type cleaners, detergents or any coil cleaner.**
15. **Do not fill the water container with anything but clean water or your warranty will be VOID.**
16. Never submerge the machine in water.
17. Do not allow the system to freeze. Always empty and store indoors. Freezing will damage the pump and water lines.
18. Do not remove cover plate or attempt to disassemble your machine. This will void all warranty and may cause serious injury.
19. ONLY use the SUPPLIED charger for your machine. Any other device may cause damage to your machine.
20. Do not spray water directly at the eyes or mouth.
21. Only use Nu-Calgon supplied 115VAC to 12VDC convertor (p/n: 4778-12) if purchased as an accessory. This commercial grade convertor is rated at 10Ah. The sprayer requires a minimum 6Ah rated convertor.

## LIMITED WARRANTY

Nu-Calgon will warrant the product for a period of 12 months from the date of purchase to be free of defects in material or workmanship. Keep your original sales invoice to validate the warranty period.

If the product should become defective within the warranty period, we will repair or replace any defective parts free of charge. **Return the sprayer to a Nu-Calgon authorized wholesaler to initiate the process of repairing or replacing the defective part. Typically the sprayer can be remedied in the field – do not send back to Nu-Calgon without prior authorization.**

The warranty does not include the rechargeable battery, usual wear and tear, damage resulting from accident or unreasonable use of the product, unauthorized repairs or parts that does not belong to the product. The sprayer is designed for clean water only. The use of any coil cleaner will void warranty since it will damage the wetted parts of the sprayer.

## FEATURES

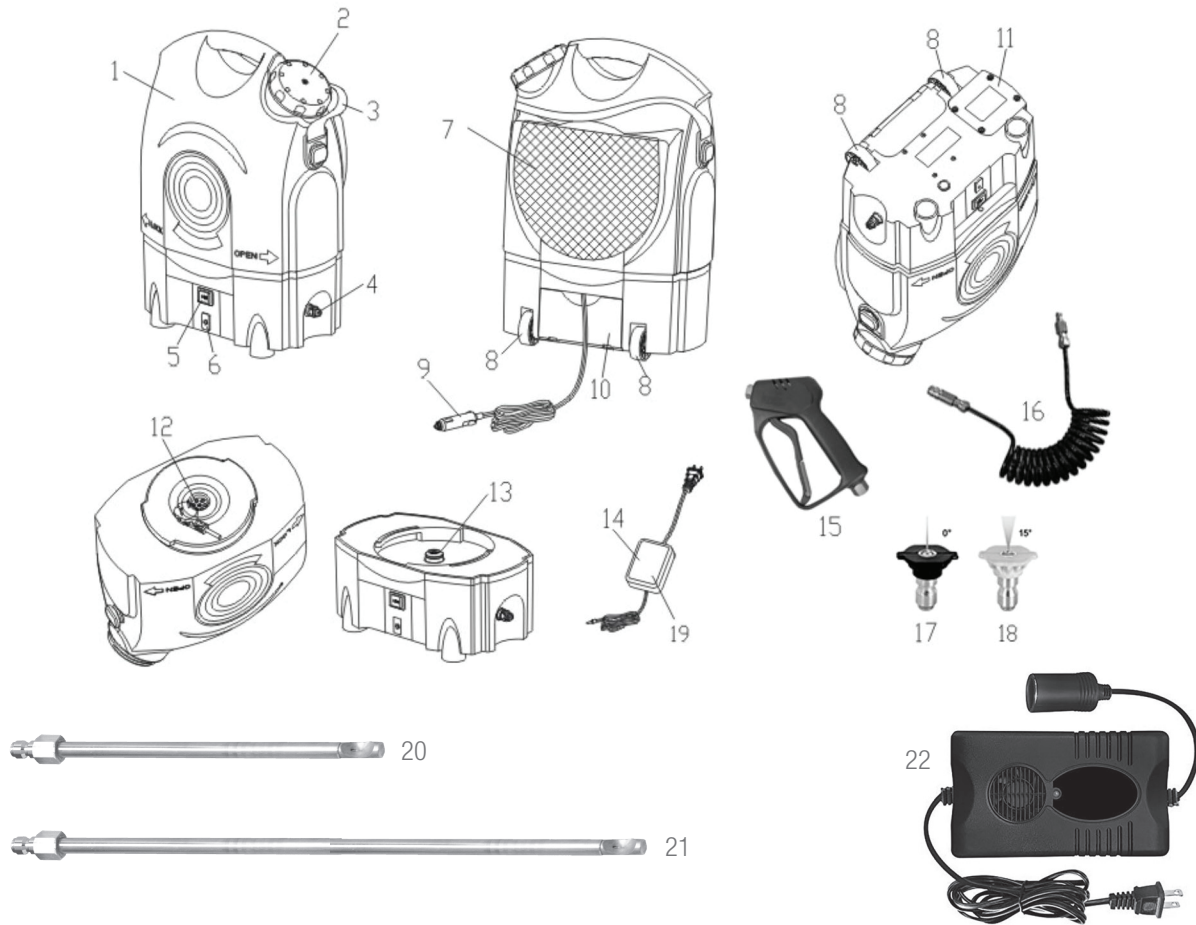

- |                              |  |
|------------------------------|--|
| 1. Water tank                | 13. Water inlet  |
| 2. Vented Cap (4778-15)      | 14. Charger (4778-22)  |
| 3. Adjustable Shoulder Strap | 15. Commercial Spray gun (4778-21)                                     |
| 4. Hose Connector            | 16. Self-Recoil Hose (4778-20)   |
| 5. Power Switch              | 17. Red Straight Nozzle (4778-13)                                      |
| 6. Inlet for charger         | 18. Yellow 15 degree Nozzle (4778-14)                                  |
| 7. Mesh Storage Compartment  | 19. Indicator (Turns from RED TO GREEN when battery is fully charged ) |
| 8. Wheels                    | 20. Mini-Split 90° spray wand (4778-10)                                |
| 9. 12VDC Vehicle Adapter     | 21. 39 inch 90° spray wand - available separately (4778-11)            |
| 10. Cover for power cord     | 22. 115VAC to 12VDC Converter - available separately (4778-12)         |
| 11. Cover for Battery        |  |
| 12. Water outlet             |  |

Note: Sprayer uses a standard Expert Power EXP 1245, 12VDC 4.5Ah rechargeable battery. Contact Nu-Calgon with questions, but could be purchased through Nu-Calgon p/n: 4778-25.

## HOW TO ASSEMBLE

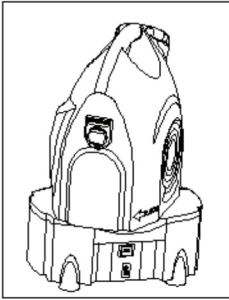

Take off the water tank

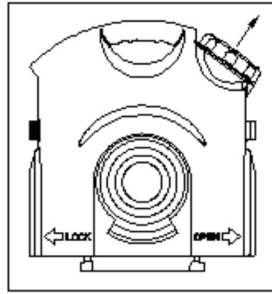

Turn lid counterclockwise to remove.

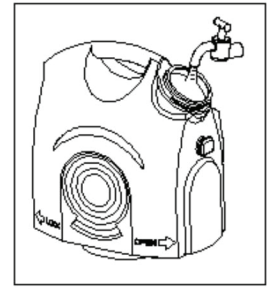

Fill tank with fresh water.

**IMPORTANT:** Temperature 10°C to 40°C WATER (40°F to 104°F)

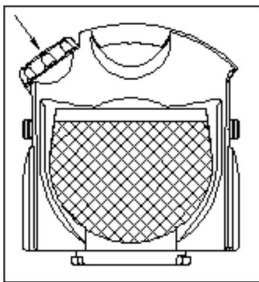

Replace lid by turning clockwise to secure in place. Reattach water tank to base following the reverse steps.



### **ATTACH SPRAY NOZZLE:**

Connect spray nozzle by pulling back on the quick connector and fully inserting the nozzle and fully releasing the quick coupling



### **ALTERNATE: MINI-SPLIT WAND**

Connect spray wand by pulling back on the quick connector and fully inserting mini-split wand (for cleaning the blower) and fully releasing the quick coupling.

## HOW TO REPLACE THE BATTERY\*

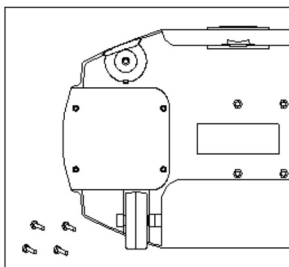

Open the cover by releasing the screws

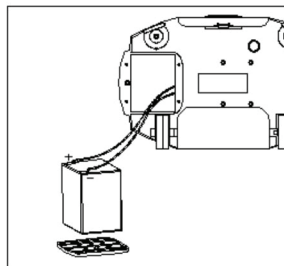

Connect battery clamps with power cord - red line for red clamp, black line for black clamp

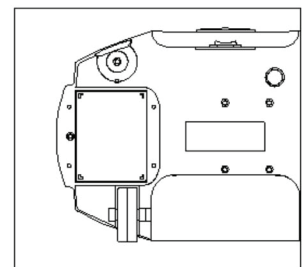

Replace the cover and reinstall all screws

\*Sprayer uses a standard Expert Power EXP1245, 12VDC 4.5Ah rechargeable lead/acid battery. Battery could be purchased through Nu-Calgon p/n: 4778-25 or readily available in the market.

# HOW TO OPERATE

**IMPORTANT WHEN USING THE 12VDC VEHICLE ADAPTER:** DISCONNECT THE POWER CABLE WHENEVER THE VEHICLE ENGINE IS TURNED OFF FOR EXTENDED PERIODS OF TIME. THE POWER DOES **NOT** TURN OFF AFTER SWITCHING OFF THE ENGINE IN CERTAIN VEHICLES. IF THE POWER PLUG IS LEFT CONNECTED, THE VEHICLE'S BATTERY MAY BECOME RUN DOWN OR DAMAGED.

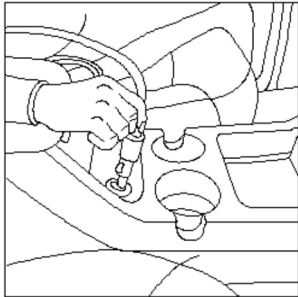

**FOR 12VDC VEHICLE ADAPTER  
(Diagram 1)**

Plug into vehicle power port.

Switch the power on "II" to use the power of the car battery

**NOTE:** Some vehicles require that the ignition be in the accessory position

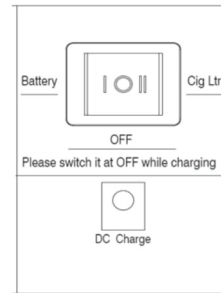

**FOR BATTERY  
(Diagram 2)**

Switch the power on "I" to use the power of the battery

**NOTE:** Charge 6 to 8 hours before using the sprayer for the first time

With normal use, air can get trapped in the hose. We recommend the following steps to purge the air out of your system and get the maximum amount of pressure out of your new Turbo Tank HVACR Rinsing Sprayer

**PURGE AIR FROM SYSTEM:** To purge air, turn the unit on "II" or "I"(Diagram2). Point nozzle into water tank and squeeze lever until steady stream of water exits the hose.

## **FOLLOW THESE STEPS AFTER EACH TIME YOU REFILL YOUR TANK:**

1. Fill the tank with water and cap tank.
2. For 12VDC Vehicle Adapter Use: Connect to vehicle's 12VDC power port. Turn unit on "II".  
For Battery: Charge battery and switch unit on to "I".  
For Optional Converter: Plug into 115VAC power source and plug 12VDC vehicle adapter on sprayer. Turn unit on "II"
3. Turn the power on and run for approximately 30 seconds or until a steady stream of water is present.
4. Connect the mini-split wand or optional 39" wand to spray gun.

**NOTE:** Please start the engine while using the device if you are not sure whether the capacity of the vehicles battery is sufficient.



# **AUTOMATIC SHUTOFF**

## **THE AUTOMATIC SHUTOFF FEATURE:**

When the trigger is released, the dynamic pressure sensor shuts the motor off automatically. When the trigger is pressed, the pressure drop automatically activates the motor and pressure is increased once again with a slight delay. To ensure the correct automatic shutoff operation, the time interval between trigger release and engagement must not be less than 5-10 seconds.

## **SHUTTING DOWN YOUR PORTABLE HVAC SPRAYER:**

1. Place the switch in the OFF position.
2. Pull trigger on spray gun to relieve any water pressure in hose or spray gun.

# GENERAL MAINTENANCE

## FOR DEVICE:

**WARNING:** ALWAYS DISCONNECT THE PLUG FROM THE POWER SUPPLY BEFORE ANY MAINTENANCE IS STARTED.

1. **WATER FILTER:** Inspect the water filter screen before filling with water. Clean the water filter screen when necessary.
2. **NOZZLE CLOGGED:** A clogged nozzle will cause the operating pressure to be too high, causing the portable sprayer to surge. If this happens turn unit off and unplug the pressure sprayer:  
Unplug power supply, pull trigger on spray nozzle handle to relieve pressure, remove nozzle from handle.
  - Flush wand assembly backwards with water or compressed air.
  - If pressure is still too high, repeat steps 1-2.
3. **LUBRICATION:** No lubrication is required for this pump. Silicone grease may be added to hose connector O-rings if connecting becomes difficult.
4. Add some silicone grease to the metal part of the spray nozzle if it has not been used for a long period of time.

## REPLACING FUSES:

The Turbo Tank Sprayer is equipped with two fuses. One fuse is located in the 12VDC vehicle adapter (See right). A fuse is also located in the battery compartment (Fuse F10AL250V). Check both if the sprayer does not power on.

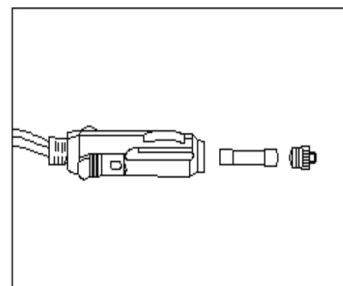

Unplug charger from wall. Unscrew end of 12VDC vehicle adapter to remove old fuse. Discard and replace with new F8AL250V fuse.

## FOR BATTERY:

1. Try to maintain a fully charged battery so the sprayer is ready for use. We recommend charging the battery fully after each use to ensure the maximum battery life. Before the first use, charge for 3-4 hours.
2. Please note that the battery's charge will reduce over time if stored without use. Ideally charge the battery at least once every three months to ensure it remains in a fully charged state.
3. Check the battery clamps regularly to ensure they are not loose, corroded, or defective.
4. Please always store the battery/Sprayer/Power Pack away from high temperatures, flammable or explosive goods.
5. To prevent electrical shock, please use an insulated tool or glove when fixing or performing maintenance.
6. Please contact your local Nu-Calgon distributor or Nu-Calgon if there is any defect of the battery. Do not disassemble the battery yourself.
7. Do not clean the battery by using solvents, as it may damage the battery.

## **STORING OF THE PORTABLE HVAC SPRAYER**

Your Turbo Tank HVACR Rinsing Sprayer should be stored in such a way to protect it from freezing. Do not store this unit outdoors or in areas where temperatures will fall below 0°C (32°F). This can cause extensive damage to this unit and void the warranty. Before storing, follow these shut down instructions:

### **DRAIN WATER FROM MACHINE:**

1. Turn off the switch, squeeze the lever to release pressure. Remove the nozzle and squeeze handle lever to drain the water. Empty the water from the tank. Turn the unit on and run it for approximately 30 seconds without the nozzle while engaging the handle lever.
2. Lower one end of the hose, engage the lever on the handle and allow the water to drain from the hose.
3. Remove and place the spray gun and power cord in the mesh storage compartments.
4. If the unit must be stored under freezing condition, or will be stored for more the 30 days, a pump winterizer/protector or a non-toxic RV anti-freeze can be used to prevent freezing and reduce mineral deposits.

### **ADD ANTI-FREEZE AS FOLLOWS:**

1. Pour approximately 3/4 gallon (3 liters) of RV anti-freeze into tank.
2. Connect high pressure hose, nozzle, and power cord.
3. Turn unit on, squeeze lever until a steady stream of RV anti-freeze is present.
4. Turn unit off. Squeeze handle lever to release pressure.
5. Remove and place the spray gun and power cord in the mesh storage compartment.

### **USING PRESSURE SPRAYER AFTER STORING WITH ANTI-FREEZE:**

1. Drain RV anti-freeze. (follow steps 1 and 2 from Drain Water from Machine)
2. Run 1 tank of fresh water through system before using and ensure that all anti-freeze is purged from the system.

**WARNING:** USE ONLY RV ANTIFREEZE. OTHER FORMULATED ANTI-FREEZE PRODUCTS FOR HVAC APPLICATIONS CAN DAMAGE PUMP AND VOID WARRANTY.

## FAQ

### PORTABLE HVAC SPRAYER DOESN'T WORK?

- Check if the power cord is attached properly.
- If using the 12VDC adapter, check the Vehicle's battery and the 12VDC vehicle adapter socket.
- Check the fuse in the 12VDC vehicle adapter.
- Check the fuse in the battery compartment.

### NO WATER SPRAYS OUT WHEN STARTING THE WATER PUMP?

- Check if the nozzle is clogged.
- Check if the water inlet or outlet is clogged.
- Check if the water inlet filter screen on the base unit is clogged.
- Check if the water hose is bent.
- 

### NOTICE:

To avoid using up the vehicle's charge, please start the engine if you need to use the 12VDC vehicle adapter for more than 30 minutes.

### Specification:

- Pressure (PSI): 43.5 to 130.5
- Volts: 12V(DC)
- Power: 60W
- Hose: 236 inches (6 meters)
- Power Cord: 118 inches (3 meters)
- Capability: 4.5 gallons (17 liters)
- G.W.: 17.2 lbs. (7.8kg)
- Dimension: 14 x 9 x 21 inches (355 x 230 x530mm)

**IMPORTANT:** Consult Nu-Calgon literature for other details. Contact Nu-Calgon for any warranty related concern. In most cases, the Turbo Tank can easily be repaired in the field.