

AE4-1329 R3
Replaces AE4-1289

July 2016

CR_KQ, CR_K6, CR_5, CR_K7 Hermetic Reciprocating Compressors

Introduction

The CR_KQ, CR_K6, CR_5 and CR_K7 Copeland® hermetic compressors include a wide range of capacities, electrical options, and features. Typical model numbers are CR18KQ-TF5 and CR31K7-PFV. This bulletin describes the operating characteristics, design features, and application requirements for these models. For additional information, please refer to the Online Product Information accessible from the Emerson website at www.emersonclimate.com.

The CR_KQ(E) is a compact, standard efficiency design ranging in capacity from 16000 BTU/H to 53000 BTU/H for both R-22 and R-407C heat pump and air-conditioning applications. Most of these models are available for both single and three phase, fifty and sixty hertz, power supply.

There are three basic CR_5 displacements, the CRP5-0450, CRT5-0450 and CRN5-0500. These are older R-22, CR designs that have had motor and valving upgrades over the years. The capacities range from 54000 Btu/H to approximately 61000 Btu/H. A modified version of the CR_5 is the CR_Q(E), built with a more restrictive muffler for sound reduction. This model is also approved for refrigerants R-22 and R-407C.

The CR_K6(E) is designed for higher efficiency systems and has a slightly more rounded shell designed for lower sound. It ranges in capacity from

16000 BTU/H to 42000 BTU/H and is released for R-22 and R-407C heat pump and air-conditioning duty. Motors are available for both single and three phase, 50 & 60 Hz. power supply

The CR_K7 is the newest member of the CR family designed for highest efficiency. There are models available ranging in capacity from 14000 BTU/H to 31000 BTU/H. This model is released for R-22 air-conditioning and heat pump applications. It is designed only for 60Hz single and three phase power supply.

These models include a number of features outlined in the matrix below:

Power Supply: All motors for the CR compressors whether single or three phase, **with the exception of the "PFV" motor used on 208-230, 1Ø, 60 Hz power supply**, are designed to operate within a voltage range of +/-10% above and below the voltages shown on the nameplate. For example a compressor with a nameplate voltage of 200-230 volts can operate within a range of 180 to 253 volts. Compressors with a "PFV" designated motor such as a CR16KQ-PFV, may only be operated in a range of 197 to 253 volts, 60 Hz under maximum load conditions.

Electrical Connections: The orientation of the electrical connections of the CR compressors is shown in **Figure 4**. All four compressor models can be ordered with either the standard ¼ inch Quick Connects that

CR Matrix						
Model	Power Supply	Application		IPR Valve	Approved Refrigerant	Electrical Connection
		AC	HP			
CR_KQ All*	1&3ph, 50/60 HZ	X	X	X	R-22 & 407C	1/4" QC & Molded Plug
CR(P,T,N)5	1&3ph, 50/60 HZ	X	X	X	R-22	Screw, Plug and 'Quick Connection
CR(P,T,N)Q	1&3ph, 50/60 HZ	X	X	X	R-22 & 407C	
CR_K6	1&3ph, 50/60 HZ	X	X	X	R-22 & 407C	1/4" QC & Molded Plug
CR--K7	1&3ph, 60 HZ	X	X	X	R-22	1/4" QC & Molded Plug

*CR53KQ is available with optional screw connection

come equipped with terminal box covers or the newer "Molded Plug" connection that requires no terminal box cover but does require the plug type connector as shown in **Figure 5**. This connector can be purchased from Emerson under part number 529-0001-XX (Various wire sizes and colors are available) or directly from the manufacturer, Kauffman Engineering Inc. in Lebanon, Indiana. (<http://www.kewire.com>) The two largest CRKQ models also offer "T-block Screw Connection" for ring termination.

Application Range and Approved Refrigerants: All four models are approved for use with refrigerant R-22. All models may be operated within the entire operating envelope shown in Figure 3. The CR_KQE, CR_K6E, CRNQE and CRTQE model families are approved for use with R-407C. Use of refrigerants other than R-22 and R-407C voids the UL listing of these models since they could affect the motor protector setting. R-407C can only be used with compressors containing Polyol Ester (POE) oil. Compressors containing POE have an "E" just before the dash in the voltage code of the model number, e.g. CR36KQE-PFV.

Oil Type

Conventional 3GS type yellow mineral oil is used in all R-22 compressors. See nameplate for original oil charge. A complete field recharge should be four fluid ounces (118 ml) less than the nameplate value. Some models have been released for use with R-407C and R-134a. These models use polyol ester oil and are identified by an "E" just before the dash in the voltage code of the model number. An example would be the CR24KQE-PFV compressor. Emerson Ultra 32 CC (PN 998-E022-XX) should be used if additional oil is needed in the field. Emkarate RL32CF oil may be used to recharge these compressors if Ultra 32 CC is not available. Compressors charged with POE oil may be used with R-22 but compressors charged with mineral oil may not be used with HFC refrigerants such as R-407C or R-134a because these refrigerants and mineral oil are not miscible.

IPR Valve-Internal Pressure Relief Valve: The internal pressure relief valve is located between the internal discharge and suction side of the compressor. It is designed to open when the discharge-to-suction pressure differential exceeds 450 to 550 psid. When the valve opens, hot discharge gas is released into the low pressure housing of the compressor. This has the effect of both increasing the suction pressure, and therefore load and current draw of the motor, as well as

the temperature in the low side of the shell. Since the motor protector reacts to a combination of temperature and current it will trip and disconnect the motor once its set point is reached. During developmental blocked fan testing, it is sometimes noted that the valve opens, but the compressor does not shut off while the discharge pressure continues to climb until an equilibrium condition is achieved. This condition is normally caused by refrigerant flood back and may be corrected by using a more restrictive expansion device or reducing the refrigerant charge.

Motor Protector: Conventional internal line break motor protection is provided. The protector opens the common connection of a single-phase motor and the center of the Y connection on three-phase motors. The three-phase protector provides primary single-phase protection. Both types of protectors react to current and motor winding temperature.

Application Considerations

The application of these reciprocating compressors designed to operate within a standard air-conditioning /heat pump envelope is fairly straight forward and uncomplicated however the following must be observed or in some cases considered for the design.

- Starting consideration, phasing and power interruption
- Operating limits
- Refrigerant charge limits
- Safety controls
- Tubing design and connections
- Mounting considerations
- Line processing

Single Phase Starting Characteristics

Equalized Pressure Starting: The starting torque of a PSC hermetic single phase piston compressor is very low. Consequently the system has to be designed to allow for high to low side pressure equalization during the off cycle. Even a couple of pounds of pressure differential between the discharge and the suction side will prevent a certain percentage of these compressors from starting. No start components are required if the system is designed to allow for off cycle pressure equalization. If the field installation has severe starting voltage drop it may be necessary to add a low torque start capacitor and relay to compensate for this. Only relays and capacitors approved by Emerson may be used for this purpose.

PTC Start Components: For less severe voltage drops or as a start boost, solid state Positive Temperature Coefficient devices rated from 10 to 25 ohms may be used to facilitate starting for any of these compressors. These devices may also be used in conjunction with start capacitors for even more starting torque but only in systems where pressure can equalize during the off cycle. It must be understood that the PTC device must have a five minute cool down period in order to assist in the starting sequence again.

Unequalized Pressure Starting: If the system design does not allow for pressure equalization, such as when a hard shut off thermostatic expansion valve is used, then a high torque start capacitor and relay must be used. Use only relay and capacitor values specified by Emerson for this purpose. Use of generic start kits is not approved and could result in compressor failure.

Run Capacitors: Only the run capacitor value specified by Emerson for each model may be used. If a specified run capacitor is not available a 5 μ f higher rated capacitor with a voltage rating equal to or higher than the specified capacitor may be used.

Electrical component values are listed in the Emerson Online Product Information database, accessed through the customer portal, www.emersonclimate.com

Three Phase Compressors

Direction of rotation and therefore proper phasing of the motor is not an issue with three phase hermetic compressors since they will pump when rotating in either direction.

Brief Power Interruption

During a brief power interruption a single phase CR compressor without start components will stall and trip on motor protector when power is restored. The motor protector will keep the compressor off till the pressures are equalized. Three phase compressors and compressors with high torque start components will start as soon as power is restored.

Time Delay: A time delay is not necessary unless a single phase CR compressor is applied to a system that might not allow sufficient time for pressure to equalize during the off cycle.

Compressor Cycling

There is no set answer to how often a compressors can be started and stopped in an hour, since it is highly

dependent on system configuration. There are two things to consider about compressor cycling.

1. Start component life. If a start capacitor and relay is applied to the system then sufficient time must be allowed for the start capacitor to cool down between cycles. This would normally limit the system to six starts per hour. If PTC start components are used they normally require 5 minutes off time to function again. Three phase compressors can be cycled more rapidly but compressors are designed for a finite cycle life and the more rapidly the compressor cycles the sooner end of life for such components as internal mounting parts, internal discharge tube or motor is reached.
2. Minimum run time. This is of almost more importance than cycling since it concerns returning oil to the compressor after start up. To establish the minimum run time obtain a sample compressor equipped with a sight tube (available from Emerson) and install it in a system with the longest connecting lines that are approved for the system. The minimum on time becomes the time required for oil lost during compressor startup to return to the compressor sump and restore a minimal oil level that will assure oil pick up through the crankshaft. Cycling the compressor for a shorter period than this, for instance to maintain very tight temperature control, will result in progressive loss of oil and damage to the compressor. See **AE17-1262** for more information on preventing compressor short cycling.

Operating Limits

Figure 3 defines the operating envelope for these compressors. This envelope was established using 20°F superheated return gas temperature and taking design compression ratio into consideration. Operation outside of this envelope may cause oil overheating, rapid bearing wear, motor overloading and protector trips. Under normal circumstances the minimum return gas superheat should not be lower than 10°F since it becomes difficult controlling liquid flood back below this point. See "Accumulators" for heat pump applications. Maximum return gas temperature should be kept below 95°F when operating above 25°F saturated suction and below 65°F when saturated suction goes below 25°F to prevent high discharge temperatures and oil overheating. Under normal operating conditions the discharge temperature should be below 250°F and the system design should not allow discharge

temperatures above 275°F even under maximum operating conditions.

System Charge Limits

All CR..KQ, CR.5, CR..K6, CR..K7 models have a six (6) pound refrigerant charge limit with the exception of models CR47KQE and CR53KQE which have a four (4) pound limit. If the system charge is above this limit either a crankcase heater or pump down must be used to keep excessive refrigerant out of the crankcase. See **Table 2**.

Crankcase Heaters

Crankcase heaters are not required when the system charge is under the charge limit listed in **Table 2**. A crankcase heater is required for systems initially designed with more than the listed charge limit, including field installation where long line length require a total system charge over this limit. Experience has shown that compressors may fill with refrigerant under certain circumstances and system configurations, notably after longer off cycles when the compressor has cooled. This may cause excessive start up clearing noise, excessively stress the valves or possibly lock up the compressor causing several protector trips before starting. The addition of a crankcase heater will reduce customer noise and dimming light complaints since the compressor will no longer have to clear out liquid during start. **Table 3** lists crankcase heaters recommended for various models and voltages. Apply the crankcase heater according to the print provided with each heater

Pump down Cycle

A pump down cycle for control of refrigerant migration is not normally used with piston compressors of this size. If a pump down cycle is used do not set the cut off pressure much below the normal system operating range. It is not necessary to achieve low suction pressure to ensure that liquid refrigerant is not present in the low side. Although the compressor may recycle one or two times to remove all liquid from the low side this is preferable to a very low suction pressure setting that might damage the compressor in a loss of charge situation. The low-pressure control differential must be carefully reviewed so that repeated short-cycling will not result in a low oil situation and consequent damage to the compressor.

Accumulators

The use of accumulators is very dependent on the

application. These compressors are designed and tested for the ability to handle liquid refrigerant during occasional operating flood back situations therefore making the use of an accumulator unnecessary in standard designs such as condensing units. Applications, such as heat pumps with orifice or cap tube refrigerant control, that allow large volumes of liquid refrigerant to flood back to the compressor during normal steady operation can dilute the oil to such an extent that bearings are inadequately lubricated and wear will occur. In such a case an accumulator must be used to reduce flood back to a safe level that the compressor can handle. To test for flood back conditions and determine if the accumulator design is adequate, please see the section entitled **Excessive Liquid Flood Back Tests** at the end of this bulletin. The accumulator oil return orifice should be from .040 to .055 inches (1 - 1.4 mm) in diameter depending on compressor size and flood back results. A large-area protective screen no finer than 30 x 30 mesh (0.6 mm openings) is required to protect this small orifice from plugging. Tests have shown that a small screen with a fine mesh can easily become plugged causing oil starvation to the compressor bearings.

Screens

The use of screens finer than 30 x 30 mesh (0.6mm openings) anywhere in the system should not be used with these compressors. Field experience has shown that finer mesh screens used to protect thermal expansion valves, capillary tubes, or accumulators can become temporarily or permanently plugged with normal system debris and block the flow of either oil or refrigerant to the compressor. Such blockage can result in compressor failure.

Safety Controls

During a system loss of charge, the compressor will be protected for some time by the motor protector. However, as refrigerant leaks out, the mass flow and the amperage draw are reduced and the compressor will start to overheat. During air conditioning operation the problem may be detected because of rising indoor temperatures before damage is done. This may not be the case during heat pump operation since backup heat will make up the deficit. A low pressure control is recommended for loss of charge protection in heat pumps for the highest level of system protection. A cut out setting no lower than 25 psig (2 kg/cm²) for air conditioning and 7 psig (0.5 kg/cm²) for heat pumps is recommended. The low pressure cut-out, if installed

in the suction line to the compressor, can provide additional protection against a TXV failed in the closed position, outdoor fan failure in heating, a closed liquid line or suction line service valve, or a blocked liquid line screen, filter, orifice, or TXV. All of these can starve the compressor of refrigerant and result in compressor failure. The low pressure cut-out should have a manual reset feature for the highest level of system protection. If a compressor is allowed to cycle too often after a fault is detected, there is a high probability that the compressor will be damaged and the system contaminated with debris from the failed compressor and decomposed oil. If current monitoring to the compressor is available, the system controller can take advantage of the compressor internal protector operation. The controller can lock out the compressor if current draw is not coincident with the contactor energizing, implying that the compressor has shut off on its internal protector. This will prevent unnecessary compressor cycling on a fault condition until corrective action can be taken.

Low Ambient Cut-Out

A low ambient cut-out is not required to limit air-to-air heat pump operation. Air-to-water heat pumps must be reviewed since this configuration could possibly run outside of the approved operating envelope **Figure 3** during low outdoor temperatures causing overheating or excessive wear.

Discharge Mufflers

All CR compressors have internal mufflers to reduce discharge pulsation. While this muffling should be adequate to eliminate the need for an external muffler in condensing units, an external muffler will most likely have to be applied with a heat pump. Because of variability between systems, tests should be performed to verify acceptability of sound performance. When no testing is performed, mufflers are recommended in heat pumps. A hollow shell muffler such as the APD054 will work quite well. The muffler should be located a minimum of six inches (15 cm) to a maximum of 18 inches (46 cm) from the compressor for most effective operation. The further the muffler is placed from the compressor within these ranges the more effective it may be. If adequate attenuation is not achieved, use a muffler with a larger cross-sectional area to inlet-area ratio. The ratio should be a minimum of 20 to 1 with a 30 to 1 ratio recommended. The muffler should be from four to six inches (10-15 cm) long.

Air Conditioning System Suction and Discharge Line Consideration

Copeland® CR compressors inherently have low sound and vibration characteristics. The internal components are spring mounted and transmit very little of the motor and pumping frequencies to the shell, eliminating noise that might otherwise be heard in the suction line.

The CR compressor makes a rocking motion along its major axis while running and a torsional motion at start up. Enough flexibility must be provided in the lines to prevent annoying start up sounds or high stresses that might cause breakage. Both suction and especially discharge lines should be tested to make sure that their natural frequency does not fall within the following ranges

For 60 hertz power,

running frequencies	53.5 - 63.5 hertz.
pumping frequencies	112.0 - 122.0 hertz

For 50 hertz power,

running frequencies	43.7 - 53.7 hertz
pumping frequencies	92.4 - 102.4 hertz

Nomenclature

The model numbers of these compressors include the approximate nominal 60 HZ capacity at standard operating conditions. An example would be the CR53KQ-TFD, which has 53,200 Btu/hr (15.6 kw) cooling capacity at the ARI high temperature air conditioning rating point when operated on 60 Hz. Note that the same compressor will have approximately 5/6 of this capacity or 44,700 Btu/hr (13.1 kw) when operated on 50 Hz current. Please refer to Online Product Information literature, available by logging in at www.emersonclimate.com, for details pertaining to other information contained in the model number.

Configuration Options

Emerson uses a bill of material system to offer various configurations and options such as mounting, tubing or electrical connection as well as external parts such as crankcase heaters or mounting parts. The bill of material consists of three numbers or numbers and letters at the end of the model number, which results in quite a variety of choices for some models. Since Emerson does not publish the entire list of choices consult your salesman or application engineer if a standard model does not suit your needs.

Suction and Discharge Fittings

All CR compressors have copper discharge fittings. The suction fitting may be either copper plated steel if it is straight out or copper when the elbow points up. Due to the different thermal properties of steel and copper, brazing procedures may have to be changed from those commonly used with copper fittings. See **Figure 6** for assembly line and field brazing procedures. To prevent damage to the motor winding, no tool should be inserted into the suction tube beyond one inch from the outer end of the suction fitting.

Operating Characteristics

Copeland® reciprocating compressors should never be used to evacuate a refrigeration or air conditioning system. The compressor may be used to pump down refrigerant in a unit as long as the pressures remain within the operating envelope shown in **Figure 3**. Prolonged operation at low suction pressures will result in high discharge temperatures and oil coking that may result in permanent damage to the piston rings and discharge valves. (See **AE24-1105** for proper system evacuation procedures.)

Shell Temperature

Since the entire shell of the CR compressor is only exposed to suction pressure it will normally be relatively cool to the touch with the exception of the compressor sump which depending on operating conditions may get as hot as 200°F. A hotter sump would indicate operation outside of approved parameters.

Brief Power Interruptions

Brief power interruptions will result in a stalled single phase compressor and motor protector trip unless the unit has a high torque start capacitor and relay kit. To avoid disruption of operation, an electronic control that can sense brief power interruptions may be used to lock out the compressor for at least five minutes to allow system pressure equalization. This control could be incorporated in other system controls (such as defrost board or thermostat), or be a stand-alone control. Three-phase models have enough torque to start the compressor against unequal pressure therefore no time delay is necessary.

Assembly Line Procedures

Pulling Plugs

All hermetic compressors are pressurized with 7 to 15 psi (.5-1 kg/cm²) of dry air before they leave the

factory. The plugs that seal the compressors should not be removed until the compressor has had sufficient time to reach factory temperature, if stored in an unheated space, and is ready to be brazed into the system. A compressor containing mineral oil should not be open to the atmosphere longer than 15 minutes. If a compressor contains POE oil, it should not be open to the atmosphere longer than 5 minutes. The larger suction tube plug must be pulled first to relieve most of the pressure in the compressor. It should be noted that the valves in the compressor may trap some residual pressure in the head and discharge tube of the compressor that might cause any oil in these areas to be sprayed out.

Assembly Line Brazing Procedure

Figure 6 discusses the proper procedures for brazing the suction line to a CR6 compressor with a copper plated steel suction fitting. **It is important to flow nitrogen through the system while brazing all joints during the system assembly process.** Nitrogen displaces the air and prevents the formation of copper oxides in the system. If allowed to form, the copper oxide flakes can later be swept through the system and block screens such as those protecting capillary tubes, thermal expansion valves, and accumulator oil return holes. The resulting blockage of oil or refrigerant may do damage resulting in compressor failure.

Pressure Test

The maximum low side pressure that the shell may be subjected to is 400 psig. Any low side pressure higher than this may result in permanent shell deformation. If a higher high side pressure is required to test a pressure control, the low side must be protected from this higher pressure by the use of a relief valve set below 400 psig.

Assembly Line System Charging Procedure

Systems should be charged on both the high and low sides simultaneously. The majority of the charge should be placed in the high side of the system to prevent bearing washout during first-time start on the assembly line. It is best to charge only vapor into the low side of the system. Do not operate compressor without enough system charge to maintain at least 7 psig (0.5kg/cm²) suction pressure. **Do not operate with a restricted suction or a disabled low pressure cut-out if so equipped.** Allowing pressure to drop below 7 psig (0.5 kg/cm²) for any length of time may overheat the cylinder area and cause early ring or

valve damage. Do not use compressor to test opening set point of a high pressure cutout. Bearings are susceptible to damage before they have had several hours of normal running for proper break in.

'Hipot' (AC High Potential) Testing

It is very unlikely that a system with a reciprocating compressor will fail a hipot test because of too much liquid refrigerant in the shell. However if more than five pounds of refrigerant is in the shell, part of the motor may be submersed in liquid causing the high potential test current leakage to go up, possibly failing the test. To lower the current leakage reading, the system should be operated for a brief period of time to redistribute the refrigerant to a more normal configuration and the system Hipot tested again. See AE bulletin 4-1294 for Megohm testing recommendations. Under no circumstances should the Hipot test be performed while the compressor is under a vacuum. The level of current leakage under similar field conditions does not present any safety issue.

Unbrazing System Components

Caution! Before opening a system it is important to remove all refrigerant from both the high and low side. If refrigerant is removed from one side of the system only it is possible that either the high or low side of the system remains pressurized. If a brazing torch is then used to disconnect tubing, the pressurized refrigerant and oil mixture could ignite when it escapes and contacts the brazing flame. **It is important to check both the high pressure and low pressure side with manifold gauges before unbrazing.** Instructions should be provided in appropriate product literature and assembly (line repair) areas. If compressor removal is required, the compressor should be cut out of system rather than unbrazed. See **Figure 6** for proper compressor removal procedure.

Compressor Functional Check

A functional compressor test during which the suction service valve is closed to check how low the compressor will pull suction pressure is not a good indication of how well a compressor is performing. **Such a test may damage the compressor.** The following diagnostic procedure should be used to evaluate whether a compressor is functioning properly:

1. Proper voltage to the unit should be verified. Determine if the internal motor overload protector has opened or if an internal motor short or ground

fault has developed. If the protector has opened, the compressor must be allowed to cool sufficiently to allow it to reset.

2. Check that the compressor is correctly wired.
3. Proper indoor and outdoor fan/blower operation should be verified.
4. With service gauges connected to suction and discharge pressure fittings, turn on the compressor. If suction pressure falls below normal levels the system is either low on charge or there is a flow blockage in the system.
5. To test if the compressor is pumping properly, the compressor current draw must be compared to published compressor performance curves using the operating pressures and voltage of the system. If the measured average current deviates more than $\pm 15\%$ from published values, a faulty compressor may be indicated. A current imbalance exceeding 15% of the average on the three phases of a three-phase compressor should be investigated further. A more comprehensive trouble-shooting sequence for compressors and systems can be found in Section H of the Emerson Electrical Handbook, Form 6400.
6. **Before replacing or returning a compressor:** Be certain that the compressor is actually defective. As a minimum, recheck a compressor returned from the field in the shop or depot for Hipot, winding resistance, and ability to start before returning to Emerson. More than one-third of compressors returned to Emerson for warranty analysis are determined to have nothing found wrong. They were misdiagnosed in the field as being defective. Replacing working compressors unnecessarily costs everyone.

Compressor Replacement after Motor Burn

In the case of a motor burn, the majority of contaminated oil will be removed with the compressor. The rest of the oil is cleaned through use of suction and liquid line filter dryers. A 100% activated alumina suction filter drier is recommended but must be removed after 72 hours. See **AE24-1105** for clean up procedures and **AE11-1297** for liquid line filter-drier recommendations. **It is highly recommended that the suction accumulator be replaced if the system contains one.** This is because the accumulator oil return orifice or screen

may be plugged with debris or may become plugged shortly after a compressor failure. This will result in starvation of oil to the replacement compressor and a second failure.

Start-up of a New or Replacement Compressor

It is good service practice, when charging a system, to charge liquid refrigerant into the high side only and charge the low side of the system with vapor only. It is not good for any compressor to have liquid refrigerant dumped from a refrigerant cylinder into the crankcase of the compressor. **Do not start the compressor while the system is in a deep vacuum.** Internal arcing may occur when a compressor is started in a vacuum. Do not operate compressor without enough system charge to maintain at least 7 psig (0.5 kg/cm²) suction pressure. **Do not operate with a restricted suction. Do not operate with the low pressure cut-out disabled.** Allowing suction pressure to drop below 7 psig (0.5 kg/cm²) for any length of time may overheat the compressor and cause early bearing and piston ring damage. Never install a system in the field and leave it unattended with no charge, a holding charge, or with the service valves closed without securely locking out the system. This will prevent unauthorized personnel from accidentally operating the system for comfort cooling and potentially ruining the compressor by operating with no refrigerant flow.

Development Tests

Excessive Liquid Flood back Tests

The following tests are for those system configurations and charge levels identified in **Figure 1** that need special testing to verify exemption from need of an accumulator. **Figure 2** should be used to determine the effectiveness of an accumulator. The compressor sump temperature during any test where the return gas superheat is near zero must always meet the guidelines of **Figure 2**.

To test for **excessive continuous liquid refrigerant flood back**, it is necessary to operate the system in a test room at conditions where steady state flood back may occur (low ambient heating operation). Thermocouples should be attached with glue or solder to the center of the bottom shell and to the suction and discharge lines approximately 6 inches (15 cm) from the shell. These thermocouples should be insulated from the ambient air to be able to record true shell and line temperatures. If the system is designed to be field charged, it should be overcharged by 15% in this

test to simulate overcharging commonly found in field installations.

The system should be operated at an indoor temperature of 70°F (21°C), and outdoor temperature extremes (0°F or -18°C or lower in heating) to produce flood back conditions. The compressor suction and discharge pressures and temperatures as well as the sump temperature should be recorded. The system should be allowed to frost up for several hours (disabling the defrost control and spraying water on the outdoor coil may be necessary) to cause the saturated suction temperature to fall to below -10°F (-23°C). The compressor sump temperature must remain above the sump temperature shown in **Figure 2** or design changes must be made to reduce the amount of flood back. If an accumulator is used, an oil return orifice size of 0.040 - .055" (1 - 1.4 mm) is recommended. (See information on Accumulators in Application Considerations and also **AE11-1247**). Increasing indoor coil volume, increasing outdoor air flow, reducing refrigerant charge, decreasing capillary or orifice diameter, and adding a charge compensator can also be used to reduce excessive continuous liquid refrigerant flood back.

Field Application Test

To test for **repeated excessive liquid flood back** during normal system off-cycles perform the **Field Application Test**. Obtain a sample compressor with a side sight tube to measure liquid level in the compressor. Set the system up in a configuration with the indoor unit elevated several feet above the outdoor unit with twenty-five feet (8 meters) of connecting tubing with no traps between the indoor and outdoor units. If the system is designed to be field charged, the system should be overcharged by 15% in this test to simulate overcharging commonly found in field installations. Operate the system in the cooling mode at the outdoor ambient, on/off cycle times, and number of cycles specified in **Table 1**. Record the height of the liquid in the compressor at the start of each on cycle, any protector trips, or any compressor stalls during each test. Review the results with Emerson Climate Technologies Application Engineering to determine if an accumulator is required for the application. The criteria for pass/fail is whether the liquid level reaches a height in the shell to cause severe starting slugs.

Table 1 Field Application Test			
Operate the system as it would be operated in an actual field installation, cycling the unit on and off for the times indicated at each ambient.			
Outdoor Ambient (°F)	85	95	105
System On-Time (Minutes)	7	14	54
System Off-Time (Minutes)	13	8	6
Number of On/Off Cycles	5	5	4

Table 2 Refrigerant Charge Limit		
Model	Charge Limit	
	Pounds	kg
CR16-53KQ	6	2.7
CR47-53KQE	4	1.8
CR(P,T,N)5/Q	6	2.7
CR--K6(E)	6	2.7
CR--K7	6	2.7

Table 3 Crankcase Heaters				
Model	Emerson Part #	Volts	Watts	Type
CR16-32KQ	018-0088-02	240	35	Belly Band
	018-0088-02	265	43	Belly Band
	018-0088-03	480	35	Belly Band
CR33-41KQ	018-0031-02	600 Max	27	Insertion PTC
CR47-53KQ	018-0031-02	600 Max	27	Insertion PTC
	018-0088-00	240	40	Belly Band
CR(P,T,N)5	018-0031-02	600 Max	27	Insertion PTC
CR_K6	018-0031-02	600 Max	27	Insertion PTC
	018-0088-00	240	40	Belly Band
	018-0088-00	265	49	Belly Band
	018-0088-01	480	40	Belly Band
	018-0088-01	575	57	Belly Band
CR_K7	018-0031-02	600 Max	27	Insertion PTC
	018-0088-00	240	40	Belly Band

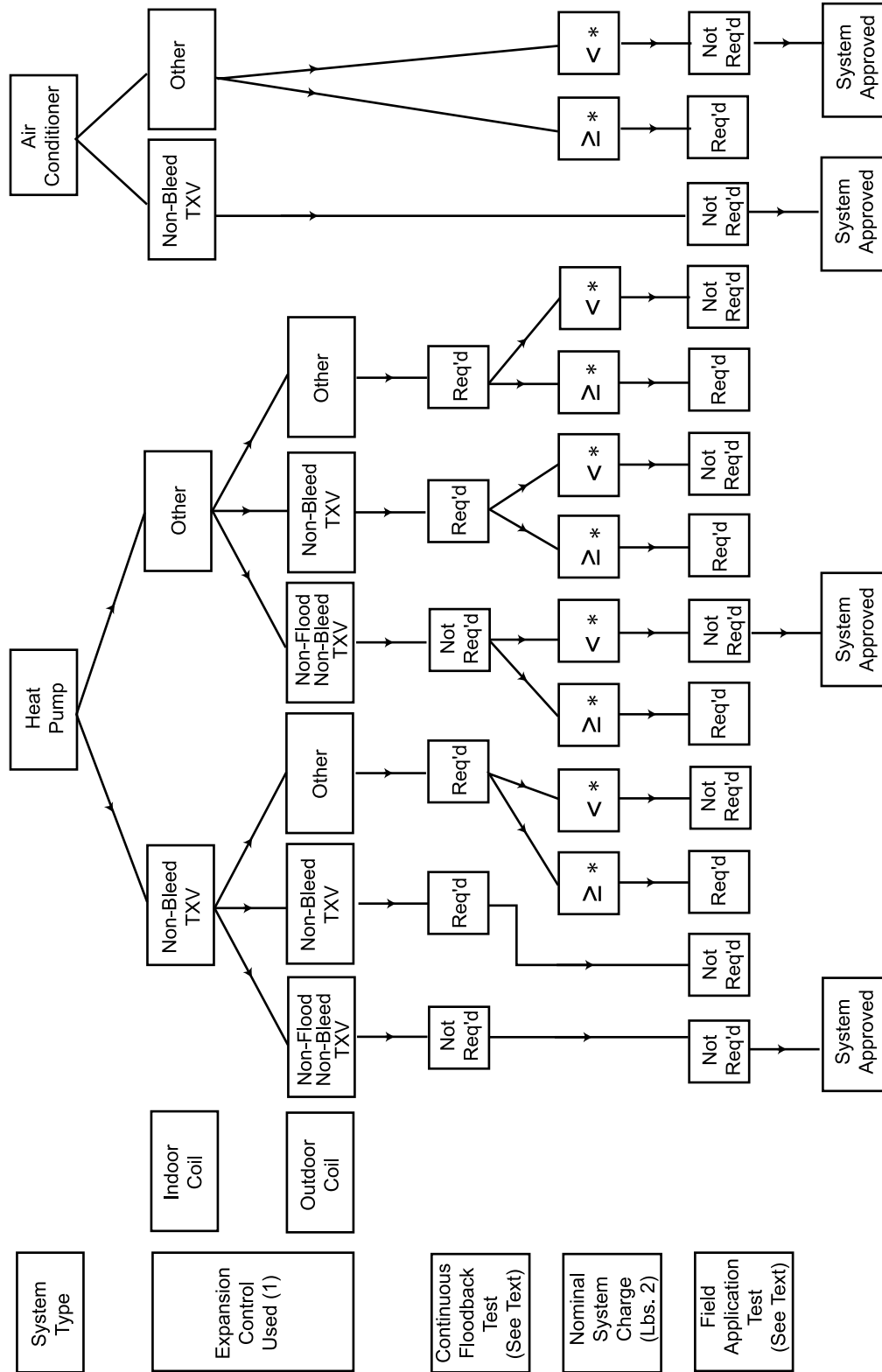

Figure 1
CR Compressor Application Diagram

(1) "Other" includes bleed-type TXVs, capillary tubes, and fixed orifices.
 (2) "Nominal System Charge" is defined as the design charge for a system (consisting of an indoor unit, outdoor unit, and connecting tubing with 25 foot connecting lines).

* See Table 2. Refrigerant Charge Limit

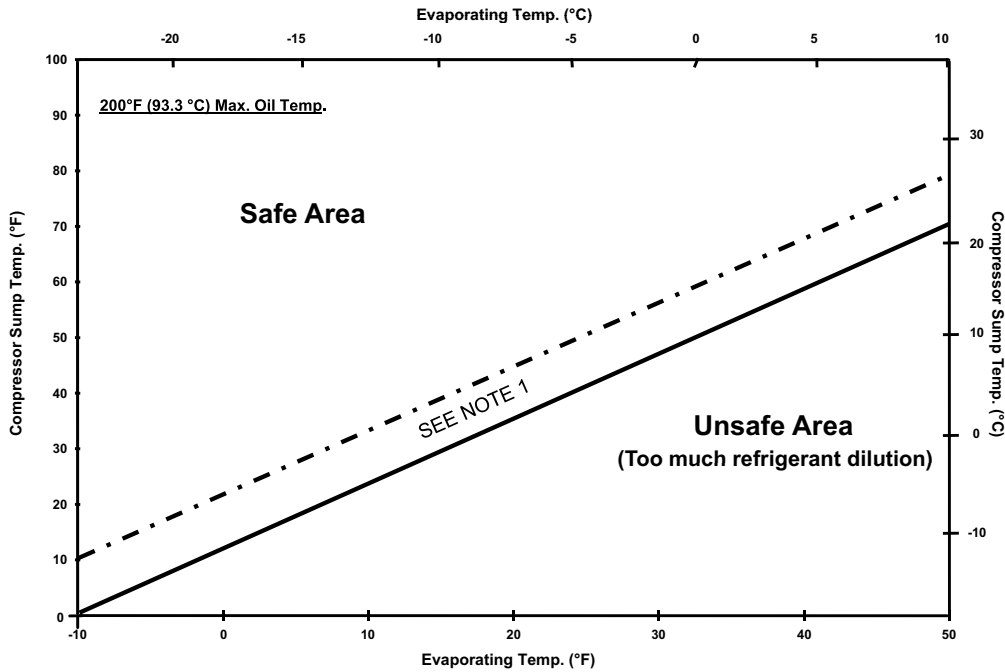

Figure 2
CR Oil Dilution Chart

Note 1: Operation in this refrigerant dilution area is safe in air to air heat pump heating mode. For other applications, such as AC only, review expansion device to raise superheat. A cold sump may result in high refrigerant migration after shut down

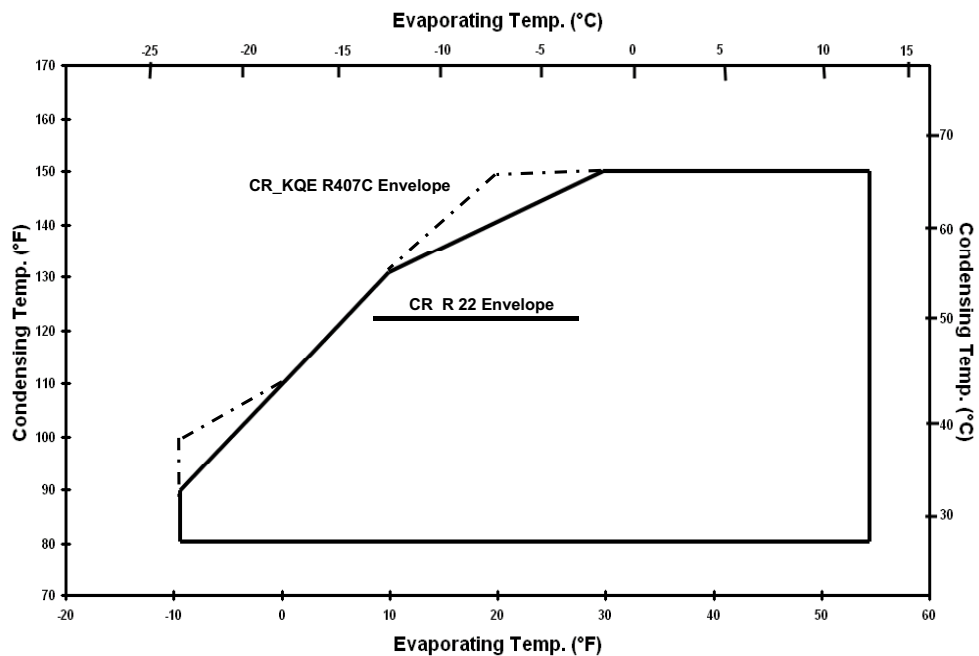

Figure 3
CR Operating Envelope

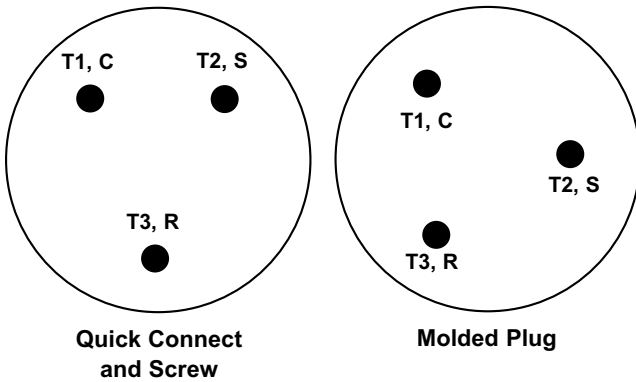

Figure 4
Electrical Connection



Figure 5
Molded Plug

Copper Plated Steel Suction Tube Brazing

New Installations

- The copper-coated steel suction tube on some CR compressors can be brazed in approximately the same manner as any copper tube.
- Recommended brazing materials: Any silfos material is recommended, preferable with a minimum of 5% silver. However, 0% silver is acceptable.
- Be sure suction tube fitting I.D. and suction tube O.D. are clean prior to assembly. If oil film is present wipe with denatured alcohol, Dichloro-Trifluoroethane or other suitable solvent.
- Using a double-tipped torch apply heat in Area 1. As tube approaches brazing temperature, move torch flame to Area 2.
- Heat Area 2 until braze temperature is attained, moving torch up and down and rotating around tube as necessary to heat tube evenly. Add braze material to the joint while moving torch around joint to flow braze material around circumference.
- After braze material flows around joint, move torch to heat Area 3. This will draw the braze material down into the joint. The time spent heating Area 3 should be minimal.
- As with any brazed joint, overheating may be detrimental to the final result.

Field Service

- To disconnect: Reclaim refrigerant from both the high and low side of the system. Cut tubing near compressor.
- To reconnect:
 - Recommended brazing materials: Silfos with minimum 5% silver or silver braze material with flux.
 - Insert tubing stubs into fitting and connect to the system with tubing connectors.
 - Follow New Installation brazing instructions.

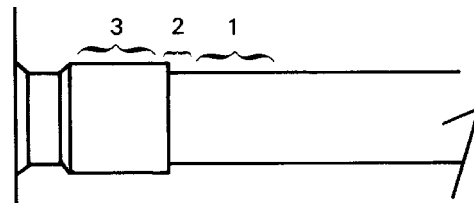

Figure 6

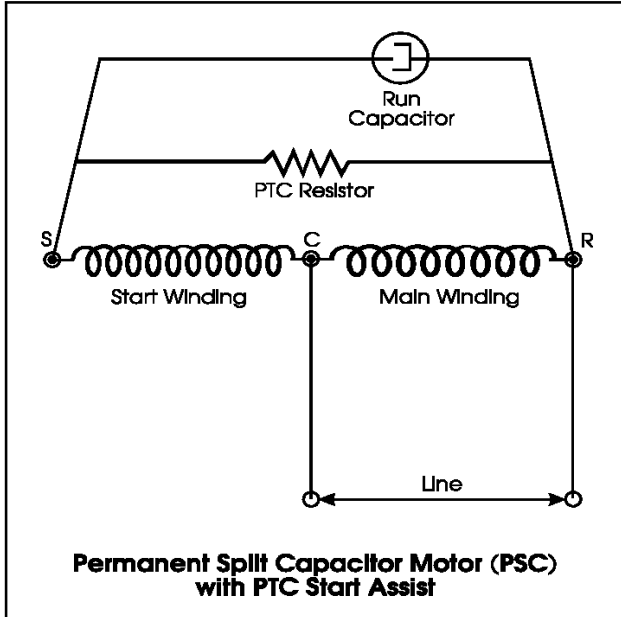

Figure 7

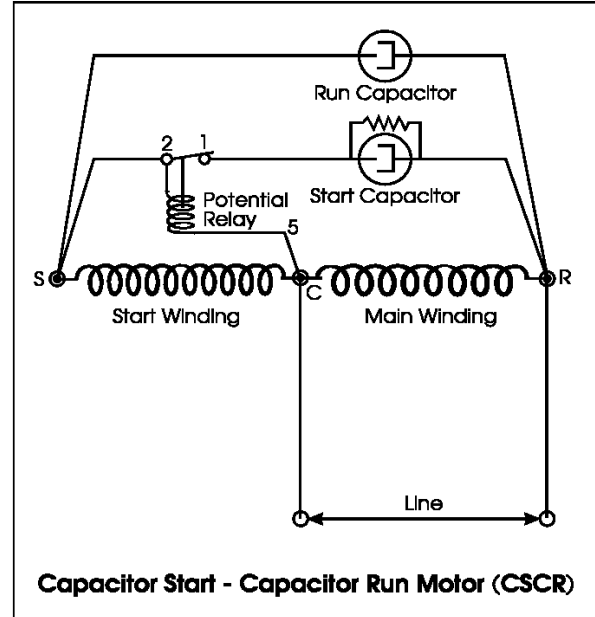

Figure 8

The contents of this publication are presented for informational purposes only and are not to be construed as warranties or guarantees, express or implied, regarding the products or services described herein or their use or applicability. Emerson Climate Technologies, Inc. and/or its affiliates (collectively "Emerson"), as applicable, reserve the right to modify the design or specifications of such products at any time without notice. Emerson does not assume responsibility for the selection, use or maintenance of any product. Responsibility for proper selection, use and maintenance of any Emerson product remains solely with the purchaser or end user.