



ERC 113 refrigeration controller reference manual

Bottle cooler controller

ERC 113

This reference manual is intended to be used primarily by OEMs for the purposes of programming ERC 113. It may also be useful for technicians. It is not intended as a user guide for end users.



Introduction

ERC 113

The ERC 113 is an electronic stand-alone controller designed to optimise total cost savings. Particularly suited for OEM customers, the controller easily meets requirements for a time-saving and flexible production setup. Programming can be carried out in just 10 seconds using the unique Danfoss docking station. Moreover, the ERC 113 is easy to mount and comes with just one code number to facilitate inventory management.

In addition to the stand-alone setup, the ERC 113 can be integrated with a remote display or a remote spindle to make it uniquely versatile. The modular system efficiently accommodates the varying requirements encountered with, for example, beer coolers, commercial freezers and glass door merchandisers.

The ERC 113 is built using the very best hardware technology and is the only controller on the market to offer a waterproof spindle.

For those customers without the need of a display and buttons, ERC 113 self contained unit controller offers a very cost effective solution. The controller's flexibility includes an optional remote spindle (same look and feel as mechanical controls) or remote display, then offering an advanced user interface.

ERC 113 in combination with the IP65 rated remote spindle ideally suits refurbishment markets, where mechanical controls need to be replaced with energy saving solutions, for instance in bottle cooler and vending machine applications. At the same time, the design meets automotive standards in terms of mounting speed and maintenance.

ERC 113 with the Danfoss remote display offers an advantage in for instance cassette design bottle coolers, where the display is mounted on the canopy, but the controller resides in the compressor compartment. For many commercial fridge and freezer applications, this split solution offers a higher degree of flexibility, due to size and an additional fifth relay.

The IP-rated body, advanced materials and internationally approved hardware design of the ERC 113 make it suitable for use in almost any climate around the world, indoors as well as outdoors. All components have been carefully selected to help reduce the CO2 footprint of the controller.

Overview of the ERC 113 application setups: stand-alone, remote display and remote spindle.

The ERC 113 stand-alone controller can be equipped with a variety of accessories, including remote display, remote spindle and multiple sensors.

Overview of the system

The ERC 113 stand-alone controller is easily programmed using the Danfoss docking station or a gateway.
Connect your PC to the USB gateway and the USB gateway to the ERC 113 and configure all parameters online. Use the gateway for various monitoring purposes in your laboratory, e.g. to verify your parameter setting.

Docking station:
download the desired parameters from a computer to an EKA 183 with USB interface. Then put the EKA 183 into the Danfoss docking station and place the ERC 113 controller on the docking station to download the parameters from the EKA 183.

Gateway:
download the desired parameters from a computer to the gateway. Then plug in the gateway into the ERC 113 controller to program it.

ERC 113 can also communicate with remote displays (e.g. RDI 107) over 1 wire communication interface or it can be controlled by the remote spindle RSP 01 through an edge connector.

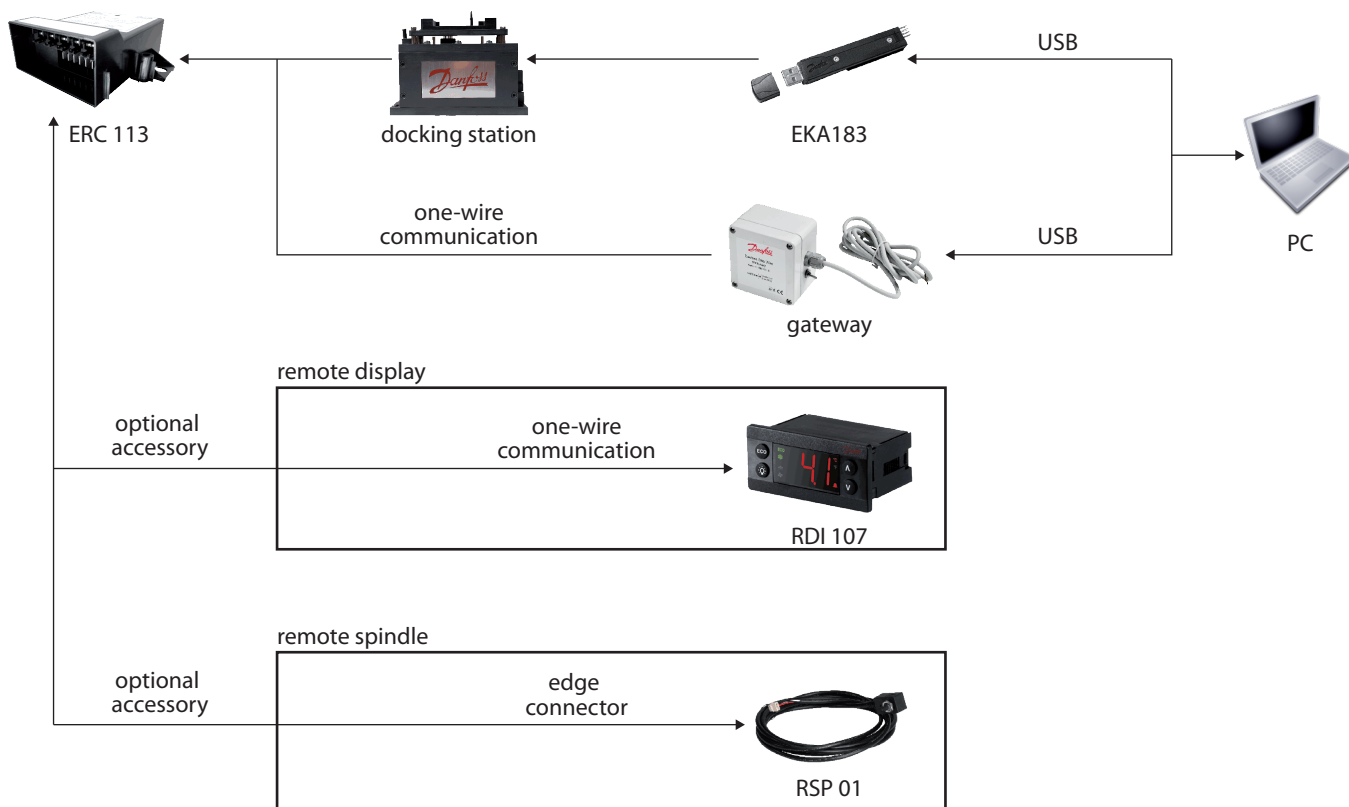

Application setup

1) ERC 113 stand-alone

The ERC 113 is an IP-rated stand-alone controller for use in applications such as beer coolers and counter-top bottle coolers (e.g. in petrol stations). With input from multiple sensors, the cost-efficient controller delivers energy-saving routines as well as providing control of compressor, light, fan and defrost functions.

Using the Danfoss docking station, programming of pre-prepared parameter settings can be achieved in just ten seconds



2) ERC 113 + remote display

The ERC 113 + remote display (RDI 107) is ideal for commercial freezers and fridges as well as glass door merchandisers.

ERC remote displays allow for temperature indication and user interaction alike in an embedded controller but with the flexibility of a split system (up to 3 meters cable length)



3) ERC 113 + remote spindle

The ERC 113 + remote spindle provides a controller solution with the look and feel of mechanical thermostats, ideally suiting refurbishment solutions and cost optimized commercial refrigeration equipment.

The remote spindle wiring is available up to 3 meters length. The spindle offers a stop function (appliance ON/OFF switch)



Configuration of inputs and outputs

ERC 113 inputs and outputs

The ERC 113 inputs and outputs are configurable by the customer. Before getting started it is a good idea to check if all inputs are configured correctly and match the sensors attached.

Input and output configuration settings are part of the assignment menu "ASi".

NOTE: Coded sensors will impact on the number of possible configurations

For instance:

Danfoss supplies only 2-pole defrost sensors, so input "S3" will most likely be used as a defrost/evaporator temperature sensor input.

Please contact your local Danfoss representative for information about default settings.

NOTE: remote display is always connected to the digital input "DI" and configured as "buS"; whilst remote spindle is always connected to "S3" and configured as "rSp"

Possible input and output connections

Inputs/outputs	Stand-alone	With remote display RDI 107	With remote spindle RSP 01
Sensor 1	X	X	X
Sensor 2	X	X	X
Sensor 3	X	X	
Sensor 4	X	X	X
Sensor 5		X	
Sensor 7		X	
Relay 2	X	X	X
Relay 3	X	X	X
Relay 4	X	X	X
Relay 5		X	
DI (not com)	X		X

The table shows the possible input and output connections for the three application setups: ERC 113 stand-alone, ERC 113 + remote display and ERC 113 + remote spindle.

Operation

Software tool/Gateway

The controller can be controlled in three ways: Using "Software tool", the Danfoss Docking Station or manually by means of the buttons on the front panel. "Software tool" is licenced Danfoss software offering easy parameter set up via a USB gateway. This software is supplied separately; for technical literature and further information, please contact your local Danfoss representative.

Docking station

Docking station is supplied separately. For further information, please contact your local Danfoss representative.

Manual operation with buttons (Direct Access)

1 Press: variable direct function, e.g. "ECO"/"Night mode"
Sub function: back

1 Press: variable direct function, e.g. light
Sub function: "OK"



1 Press: temperature set point
Sub function: "up"

1 Press: temperature set point
Sub function: "down"

Examples

Changing the desired temperature set point:

1. The display shows the current temperature.
2. Press "up/down" to access set point.
3. Press "up/down" to adjust set point.

After 30 seconds, the display automatically reverts to showing the current temperature

Turning ON/OFF the ECO function:

1. Press "ECO".

The green "ECO" symbol is lit when in "ECO" mode.

Turn ON/Off the light:

1. Press the "Light" button.

Acknowledging alarms:

1. Display Flashing the alarm message.
2. Press any button to acknowledge.

Password protection:

1. Press "up/down" and hold 5 seconds to access the menu.
2. The display shows "PAS".
3. Press "OK".
4. Press "Up/Down" to the code.
5. Press "OK".

Password protection on three levels:

1. Level 1: "shop" (daily use by shop personnel).
2. Level 2: "ser" (service technician).
3. Level 3: "OEM" (OEM programming).

Changing a parameter

Some parameters may be hidden to you. When scrolling through menus, the parameters available will have been pre-determined using "Software tool".

Your access level will determine which parameters you can view and edit:

1. Press "up/down" and hold 5 seconds to access the menu.
2. First parameter group is shown "tHE".
3. Press "up/down" to find the desired group.
4. Press "OK".
5. First parameter is shown.
6. Press "up/down" to find the desired parameter.
7. Press "OK".
8. Press "up/down" to find the desired setting.
9. Press "OK".

After 30 seconds, the display automatically reverts to showing the current temperature. Or press 2 x "Back".

NOTE:

Incorrect parameter settings can lead to inadequate cooling, excessive energy consumption, unnecessary alarms and in the case of temperature-sensitive food storage, breaches in food hygiene principles and regulations. Only a trained operator should make changes to parameters.

Menu/functions

ERC menu code		Description
"tHE"		Thermostat settings
	"SEt" Min. -100.0°C Max. 200.0°C Default 2.0°C	Set point This parameter defines the desired temperature (set point). In standard operation the set point is changed by simply pressing the "temperature up/down" buttons on ERC 112; for laboratory and assembly line you may opt for software controlled set point adjustment (speed improvement)
	"SPr" Min. 0.0 Max. 1.0 Default 0.5	Current set point adjustment value diF * SPr The default value is set to 0.5 and the parameter is hidden by default. "Spr" defines the position of the set point in relation to cut-in and cut-out. "Spr=0,5" sets the set point mid between cut-in and cut-out. "Spr=0" sets the set point at the cutout. "Spr=1" sets the set point at cut-in.
	"diF" Min. 0.0 K Max. 20.0 K Default 2.0 K	Thermostat differential This defines the difference between the cut-out and the cut-in. The desired temperature is determined by "SPr" and "diF".
	"HSE" Min. -100.0°C Max. 200.0°C Default 50.0°C	Upper limit of thermostat set point Define the temperature range limit of the controller. Once set, the desired temperatue (set point) can not go above "HSE" or below "LSE".
	"LSE" Min. -100.0°C Max. 200°C Default -35.0°C	Lower limit of thermostat set point Define the temperature range limit of the controller. Once set, the desired temperatue (set point) can not go below "LSE".
	"iCt" Min. no Max. yes Default no	Initial cut in Comp relay action when Tair is between cut-in and cut-out at power-up: "yES": cut in the compressor. "no": cut out the compressor.
	"SSA" Min. 0 Max. 80 Default 30	Spindle stop angle Set to zero to disable stop function. Set to 30 to enable stop function.
FAn		Fan settings
	"Fct" Default FAo	Fan control method "FAo": fan always on "SEt": fan follow compressor by manually settings "Aut": automatical fan control
	"Fod" Min. 0 s Max. 240 s Default 0 s	Fan ON Delay/Fod Fod defines the fan delay (in seconds) after a compressor cut-in.
	"FSd" Min. 0 s Max. 240 s Default 0 s	Fan Stop Delay/FSd "FSd" defines the fan delay after a compressor cut-out. If both "Fod" and "FSd" are set to zero then the fan runs whenever the compressor runs.
	"FoC" Min. 0 s Max. 960 s Default 0 s	Fan ON Cycle/FoC Fan Stop Cycle/FSC When the compressor is OFF, and "FoC" or "FSC" are not zero, the fan runs in cycles according to "FoC" and "FSC".
	"FSC" Min. 0 s Max. 960 s Default 0 s	Example: "FoC=120" [sec] and "FSC=120" [sec] means that the fan runs for half the time when the compressor is OFF. When the compressor is on, the fan is always ON (according to "FAo" and "Fod").
	"FSt" Min. 0 s Max. 960 s Default 10 s	Fan Minimum Stop time Minimum stop time for fan protection.

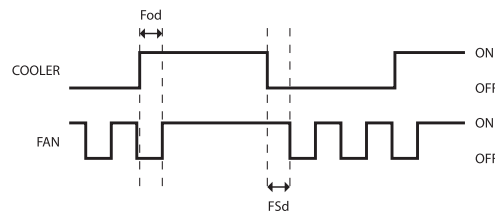
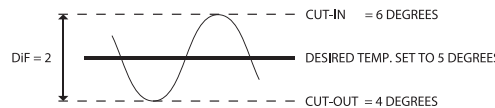

	<p>"FdC"</p> <p>Min. -10.0 K Max. 10.0 K Default 0.0 K</p>	<p>Fan Δt cut in Delta T for fan to cut in which the temperature offset comparing with thermostat cut in temperature.</p>
	<p>"Fdt"</p> <p>Min. 0 s Max. 999 s Default 0 s</p>	<p>Fan stop time on door open The delay with wich the fan will be stopped after the door has been opened. "0": fan stop immediately when door open. "1-998": delay for fan stop after door open. "999": fan keep running all the time during door open.</p>
<p>Lig Light settings</p>		
	<p>"CLC"</p> <p>Min. on Max. dor Default on</p>	<p>Cabinet Light Source Control This parameter can be set to one of these alternatives to control the light in the cabinet: "on": always ON. "oFF": always OFF. "dor": door sensor only.</p>
	<p>"Lod"</p> <p>Min. 0 s Max. 300 s Default 0 s</p>	<p>Light OFF delay Number of seconds the light will stay ON after the door has been closed.</p>
<p>Pud Pull Down settings</p>		
		<p>Pull down (sometimes known as Super Cool) is a procedure for improving cooling performance, accelerating the time used to reach the desired temperature. Pull down settings overrule all other settings.</p>
	<p>"Pit"</p> <p>Min. -40.0°C Max. 50.0°C Default 50.0°C</p>	<p>Pull Down Initiate Temperature This parameter indicates the temperature which causes a pull down to start. If the temperature measured inside the cabinet exceeds this value for longer than one hour, then pull down will start. The compressor will have already cut-in, so the only effect is to stop defrost cycles until the desired temperature is reached. The period of one hour is fixed and cannot be altered.</p>
	<p>"PCy"</p> <p>Min. 0 min Max. 360 min Default 30 min</p>	<p>Pull Down Cycling This is the duration in minutes of the compressor cycling at the reduced set point temperature. Once the desired pull down limit temperature "PLt" has been reached during pull down, the compressor will continue to cycle ON/OFF for the duration of "PCy". At the end of the period defined by "PCy", the set point temperature will return to normal and pull down will cease.</p>
	<p>"Pdi"</p> <p>Min. 0 hour Max. 48 hour Default 15 hour</p>	<p>Pull Down Defrost Interval Even though most applications do not need Defrost during pull down, an extended defrost during pull down can be applied. This is the time between defrost cycles during pull down. It is measured in hours and can be up to 48 hours. During pull down, this setting overrides the defrost interval and defrost time settings (see the defrost section).</p>
	<p>"Pdd"</p> <p>Min. 0 hour Max. 48 hour Default 24 hour</p>	<p>Pull Down Duration You can choose to limit the maximum pull down time. Once this time value (max. 48 hours) is reached, pull down will stop regardless of whether the desired pull-down temperature has been reached.</p>
	<p>"PLt"</p> <p>Min. -55.0°C Max. 55.0°C Default 0.0°C</p>	<p>Pull Down Limit Temperature This parameter sets the minimum allowed temperature during pull-down. In order to protect valuable contents you must always specify the absolute minimum temperature allowed in your application. For glass door merchandisers 0°C/32°F protects bottles from freezing; for commercial fridges you may opt for a slightly higher temperature (e.g. 2°C)</p>

	<p>"Prt"</p> <p>Min. 0.0 K Max. 10.0 K Default 0.1 K</p>	<p>Pull Down Reduction Temperature Δt</p> <p>The controller calculates a lower set point during pull down mode to increase the cooling capacity of your appliance. For each hour the cabinet temperature is above the pull down initiate temperature, the set point is reduced with the value of "Prt".</p>
<p>dEF Defrost settings</p>		
	<p>"dFt"</p> <p>Default no</p>	<p>Defrost Type</p> <p>"no": defrost function is disabled. "EL": electrical or time defrost. "Hgd": hot gas defrost (contact Danfoss for details). "nat": OFF-cycle defrost (natural defrost).</p>
	<p>"Add"</p> <p>Min. no Max. yes Default no</p>	<p>Adaptive defrost</p> <p>"no": defrost controlled by time. "yES": automatic defrost control activated.</p>
	<p>"dtt"</p> <p>Min. 0.0°C Max. 25.0°C Default 6.0°C</p>	<p>Terminate Temperature</p> <p>This parameter defines at what temperature the defrost cycle will stop. The temperature is given by the evaporator sensor or by the cabinet temperature sensor if no evaporator sensor is used.</p>
	<p>"drt"</p> <p>Min. 0.0°C Max. 200.0°C Default 5.0°C</p>	<p>Defrost reset temperature</p> <p>The defrost counter is saved and restored at power-up, but if the temperature sensor, used for defrost, is higher than this value at power-up, it is assumed that the evaporator is free of ice and the defrost counter will be cleared.</p>
	<p>"dii"</p> <p>Min. 1 hour Max. 96 hour Default 6 hour</p>	<p>Defrost minimum Interval/dii</p> <p>Defines the minimum time period between the start of two defrost cycles. Once the minimum interval has expired, the defrost cycle will start at the following cut-out or once the maximum interval "dAi" has been reached.</p>
	<p>"dAi"</p> <p>Min. 1 hour Max. 96 hour Default 7 hour</p>	<p>Maximum Interval</p> <p>Defines the maximum time period between the start of two defrost cycles.</p>
	<p>"dit"</p> <p>Min. 0 min Max. 240 min Default 5 min</p>	<p>Minimum Time</p> <p>Defines the minimum duration of a defrost cycle. During this period, the controller will not check the temperature. Once the minimum time has expired, the temperature will be checked and if the terminate temperature "dtt" has been reached, the defrost cycle will end. If dtt has not been reached, defrost will continue until either dtt is reached or the maximum time "dAt" reached, whichever occurs first.</p>
	<p>"dAt"</p> <p>Min. 0 min Max. 480 min Default 30 min</p>	<p>Maximum Time</p> <p>Defines the maximum duration of a defrost cycle. The controller will not allow a maximum time to be entered which is less than the minimum time, or a minimum time which is more than the maximum time.</p>
	<p>"dot"</p> <p>Min. 0 min Max. 60 min Default 0 min</p>	<p>Drip OFF Time</p> <p>This parameter can be set to between 0 and 60 minutes and defines how long the delay is between the heater being switched OFF and the compressor starting again.</p>
	<p>"Fdd"</p> <p>Min. 0 s Max. 600 s Default 0 s</p>	<p>Fan Delay after Defrost</p> <p>Defines how long the delay is between the start of the compressor after defrost and the fan starting again.</p>

<p>"Ftd"</p> <p>Min. -25.0°C Max. 25.0°C Default 25.0°C</p>	<p>Fan Start Temperature</p> <p>This only applies if an evaporator temperature sensor is fitted. This parameter determines at what evaporator temperature the fan will start after a defrost cycle is complete. If the time set in "Fdd" occurs before the temperature set in "Ftd", the fan will start in line with "Fdd". If the temperature set in "Ftd" occurs first, then the fan will start in line with "Ftd". It is therefore a case of whichever parameter's setting is reached first which determines when the fan starts.</p>	
<p>"dFA"</p> <p>Min. no Max. yes Default no</p>	<p>Defrost Fan On</p> <p>Set to "yES", the fan will constantly run during defrost cycles. Set to "no", the fan will not run during defrost cycles.</p>	
<p>"dCt"</p> <p>Min. no Max. yes Default no</p>	<p>Defrost ON Compressor Time</p> <p>If this parameter is set to "yES", then defrost time is considered only when compressor is ON, so that defrost cycles are based on the total time the compressor has been running. If this parameter is set to no, then defrost cycles are related to elapsed time, regardless of how long and how often the compressor has been on.</p>	
<p>"doC"</p> <p>Min. 0 hour Max. 24 hour Default 0 hour</p>	<p>Defrost by Comp. running time</p> <p>Continuous compressor running can cause defrost. "0" = deactivated</p>	
<p>"dEt"</p> <p>Min. -50.0°C Max. 0.0°C Default -50.0°C</p>	<p>Defrost start evaporator temp</p> <p>Defrost start trigger for adaptive defrost.</p>	
<p>"ddt"</p> <p>Min. 0.0 K Max. 30.0 K Default 5.0 K</p>	<p>Defrost Δt</p> <p>Defrost Δt compare with evaporator temperature of first cut out after defrost to trigger defrost start. The defrost start if evaporator temperature has decreased more the "ddt"</p>	
<p>"idd"</p> <p>Min. 0 Max. 999 Default 100</p>	<p>Initial Defrost Duration</p> <p>The initial defrost duration is the number of compressor cycles before the initial defrost is deactivated. "0": "idd" No initial defrost. "1-998": number of compressor cycles before deactivation. "999": initial defrost always active.</p>	
<p>CoP</p>	<p>Compressor settings</p>	
<p>"uPt"</p> <p>Min. no Max. yes Default no</p>	<p>Voltage protection</p> <p>"no": no voltage protection. "yES": voltage protection activated based on voltage related settings.</p>	

<p>"uLi"</p> <p>Min. 0 V a.c. Max. 270 V a.c. Default 0 V</p>	<p>Minimum cut-in voltage/uLi. Minimum cut-out voltage/uLo. Maximum voltage/uHi</p> <p>These three parameters provide voltage protection to the compressor. Start by setting "uHi", followed by "uLo" and "uLi".</p>	
<p>"uLo"</p> <p>Min. 0 V a.c. Max. 270 V a.c. Default 0 V</p>	<p>"uLi": when the compressor is due to start, the voltage of the power supply will be checked and the compressor will only be allowed to start if it is at least the value given in this parameter.</p> <p>"uLo": when the compressor is running, it will be switched OFF if the voltage goes below that given in this parameter.</p>	
<p>"uHi"</p> <p>Min. 0 V a.c. Max. 270 V a.c. Default 270 V</p>	<p>"uHi": when the compressor is running, it will be switched OFF if the voltage exceeds that given in this parameter. If the compressor is already stopped, it will remain switched OFF.</p>	
<p>"EHd"</p> <p>Default no</p>	<p>Sensor Error Type</p> <p>"no": no sensor error handling. "SEt": in case of control sensor error, follow error run/stop time. "Aut": automatical sensor error handling.</p>	
<p>"Ert"</p> <p>Min. 0 min Max. 60 min Default 0 min</p>	<p>Error Run Time</p> <p>The parameter only become active in the unlikely event of a broken temperature sensor. It is used to run the application in safety mode. At the same time the sensor error will be shown in the display. "Ert" define the duration the compressor will run. Example: "Ert=4" [min] and "Est=16" [min] will provide an average cooling system activity of 20%. Ert and "Est" values are based on OEM experience and are by default inactive.</p>	
<p>"Est"</p> <p>Min. 0 min Max. 60 min Default 1 min</p>	<p>Error Stop Time</p> <p>The parameter only become active in the unlikely event of a broken temperature sensor. It is used to run the application in safety mode. At the same time the sensor error will be shown in the display. "Est" define the duration the compressor will be "idle".</p>	
<p>"CSt"</p> <p>Min. 0 min Max. 30 min Default 2 min</p>	<p>Minimum Stop Time</p> <p>It determines the minimum number of minutes the compressor must remain idle before a Temperature cut-in can take effect. For example, if the temperature sensor indicates that the cut-in temperature has been reached, but the number of minutes set in this parameter have not elapsed since the compressor last stopped, then the compressor will stay OFF. It will only start once the duration given by "CSt" has been reached provided the temperature is still high enough. "CSt" thus overrides the cut-in.</p>	
<p>"Crt"</p> <p>Min. 0 min Max. 30 min Default 0 min</p>	<p>Minimum Run Time</p> <p>It determines the minimum number of minutes the compressor must run before a Temperature cut-out can take effect. For example, if the temperature sensor indicated that the cut-out temperature has been reached, but the number of minutes set in this parameter have not elapsed since the compressor last started, then the compressor will continue. It will only stop once the duration given by "Crt" has been reached – provided the temperature is still low enough. "Crt" thus overrides the cut-out.</p>	
<p>"Cot"</p> <p>Min. 0 min Max. 480 min Default 0 min</p>	<p>Maximum OFF Time</p> <p>This is the maximum time in minutes the compressor is allowed to "idle" – up to 480 minutes. Cot is set to zero by default (inactive). If the controller is used on a draft beer (ice bank) application, this parameter can be used to control the ice thickness.</p>	
<p>"Cdd"</p> <p>Min. 0 min Max. 15 min Default 0 min</p>	<p>Compressor Door Open Delay/Cdd</p> <p>This parameter sets the delay in minutes before the compressor stops when the door is opened. If set to zero, the function is disabled.</p>	
<p>"Srt"</p> <p>Min. 0 min Max. 60 min Default 0 min</p>	<p>System resume after door open</p> <p>Fan and Compressor resume after cut out by door open.</p>	

	<p>"Pod"</p> <p>Min. 0 s Max. 300 s Default 300 s</p>	<p>Power ON Delay</p> <p>This is the delay in seconds between power-on and the compressor being activated.</p> <p>Depends on the power ON temperature setting as explained below.</p>
	<p>"Pot"</p> <p>Min. -100.0°C Max. 200.0°C Default -100.0°C</p>	<p>Power ON Temperature</p> <p>This parameter is used to accelerate the first application test on the OEM assembly line; if the cabinet temperature is higher than this parameter the power ON Delay is overruled and the outputs are activated without delay.</p>
<p>Con Condenser Protection settings</p>		
		<p>NOTE: A condenser temperature sensor is required to use these parameters. Condenser protection is generally used in dusty environments where the condenser may accumulate a layer of dust or dirt and therefore be at risk of overheating.</p>
	<p>"CAL"</p> <p>Min. 0°C Max. 200°C Default 80°C</p>	<p>Condenser Alarm Limit/CAL</p> <p>This parameter sets the temperature for the condenser at which an alarm will be generated.</p>
	<p>"CbL"</p> <p>Min. 0°C Max. 200°C Default 85°C</p>	<p>Condenser Block Limit/CbL</p> <p>This parameter sets the temperature which if reached will cause the compressor to switch OFF.</p>
	<p>"CoL"</p> <p>Min. 0°C Max. 200°C Default 60°C</p>	<p>Condenser OK Limit/CoL</p> <p>This parameter sets the temperature at which the compressor is allowed to start again after the temperature set in "CbL" above has been exceeded and the compressor stopped.</p>
	<p>"CLL"</p> <p>Min. -100°C Max. 20°C Default -5°C</p>	<p>Condenser Low Limit/CLL</p> <p>This parameter sets the lowest (condenser) temperature at which the compressor is allowed to start.</p>
<p>diS Display settings</p>		
		<p>NOTE: some display parameters can be set in such a way that they may be illegal in some jurisdictions. Please check local legislation.</p>
	<p>"diC"</p> <p>Min. no Max. yes Default no</p>	<p>Display intensity auto control</p> <p>"no": display intensity use fixed value.</p>
	<p>"din"</p> <p>Min. 2 Max. 10 Default 10</p>	<p>Display Intensity</p> <p>The controller can have its display intensity (brightness) set in one of two ways:</p> <p>A) With a Danfoss ambient light sensor attached, the brightness of the display is adjusted automatically according to the ambient light level (see the assignments section).</p> <p>B) When no ambient light sensor is attached, the display intensity can be set to a fixed intensity.</p> <p>Both options are on a scale of 1 to 10, where 10 is the brightest.</p>
	<p>"CFu"</p> <p>Min. °C Max. °F Default °C</p>	<p>Display Unit</p> <p>This parameter sets the display to Fahrenheit or Celsius. Switching from one to the other will cause all temperature settings to be automatically updated accordingly.</p>
	<p>"trS"</p> <p>Default SCo</p>	<p>Temp sensor to display</p> <p>"SCo": temperature control. "EuA": evaporator temperature. "Con": condenser temperature (condenser cleaning). "AuS": only for showing on display.</p>

<p>"rES"</p> <p>Min. 0.1 Max. 1 Default 0.1</p>		<p>Display Resolution</p> <p>This parameter can be set to 0.1, 0.5 or 1 and affects the way the temperature is displayed. With the parameter set to 1, the display will only ever show temperatures rounded to the nearest whole degree. At 0.5, it will round the temperature to the nearest half degree for display. For example, 3.3 degrees will be shown in the display as 3.5 degrees and 3.9 as 4.0. With the parameter set to 0.1, no rounding occurs. This parameter does not affect the temperature itself, merely the display.</p>	
<p>"rLt"</p> <p>Min. no Max. yes Default no</p>		<p>Display Range Limit</p> <p>In some point of sales applications you may want to show the desired instead of the real temperature. This parameter sets whether the displayed temperature is the actual temperature or whether it is restricted to the cut-in / cut-out limits. Set to "nO" means that the actual temperature will be displayed. The parameter is set to "nO" by default.</p>	
<p>"ddl"</p> <p>Min. 0 s Max. 10 min Default 0 min</p>		<p>Display Delay</p> <p>In order to provide a realistic temperature appearance for an application, a display delay can be set. The parameter sets the time constant τ (tau) of the moving average filter for the display. Physically, one time constant represents the time it takes the system's step-response to reach 66% of its final value and five time-constants the time it takes to reach 99% of its final value.</p>	
<p>"doF"</p> <p>Min. -10.0 K Max. 10.0 K Default 0.0 K</p>		<p>Display Offset</p> <p>This parameter is a relative value and allows the temperature displayed to be different to the temperature measured. For instance, at a measured temperature of 7°C and "doF" set to -2K, the displayed temperature will be 5°C instead.</p>	
<p>"dLt"</p> <p>Min. 0 min Max. 60 min Default 15 min</p>		<p>Lock Time After Defrost</p> <p>In order not to show a rising temperature during defrosting, the displayed temperature is locked at the temperature shown at the start of the defrost cycle for the number of minutes set in this parameter. "0": no lock.</p>	
<p>"SEC"</p> <p>Min. no Max. yes Default no</p>		<p>Show Economy State</p> <p>If set to "yES", this parameter causes the display to show ECO when the system is in ECO mode. If set to "nO", the temperature continues to be displayed.</p>	
<p>"SSC"</p> <p>Min. no Max. yes Default no</p>		<p>Show Pull down state</p> <p>If set to "yES", this parameter causes the display to show SC when the system is in pull down mode. If set to "nO", the temperature continues to be displayed.</p>	
<p>"SHo"</p> <p>Min. no Max. yes Default no</p>		<p>Show Holiday</p> <p>"no": display will show temperature or ECO mode during holiday mode. "yES": display will show "HoL" during holiday mode.</p>	
<p>"SdF"</p> <p>Min. no Max. yes Default yes</p>		<p>Show Defrost</p> <p>If set to "yES", this parameter causes the display to show DEF when the system is in defrost mode. If set to "nO", the temperature continues to be displayed.</p>	
<p>"SCS"</p> <p>Min. no Max. yes Default yes</p>		<p>Show compressor symbol</p> <p>"no": compressor symbol will not show on display. "yES": show compressor symbol on display.</p>	
<p>"SFS"</p> <p>Min. no Max. yes Default yes</p>		<p>Show Fan symbol</p> <p>"no": fan symbol will not show on display. "yES": show fan symbol on display.</p>	

	<p>"SdS"</p> <p>Min. no Max. yes Default yes</p>	<p>Show Defrost symbol</p> <p>"no": defrost symbol will not show on display. "yES": show defrost symbol on display.</p>
	<p>"SES"</p> <p>Min. no Max. yes Default yes</p>	<p>Show ECO symbol</p> <p>"no": ECO symbol will not show on display. "yES": show ECO symbol on display.</p>
ALA		Alarm settings
	<p>"HAt"</p> <p>Min. -100.0°C Max. 200°C Default 15.0°C</p>	<p>High Temp Alarm</p> <p>Absolute value. By setting "HAt" to the maximum alarms will be deactivated.</p>
	<p>"LAt"</p> <p>Min. -100.0°C Max. 200°C Default -50.0°C</p>	<p>Low Temp Alarm</p> <p>Absolute value. By setting "LAt" to the minimum value, alarms will be deactivated. In most situations, the low alarm delay will be set to 0 to warn about too low a temperature immediately.</p>
	<p>"Htd"</p> <p>Min. 0 min Max. 240 min Default 30 min</p>	<p>Alarm delay on high temperature alarm</p> <p>The number of minutes to wait before sounding an alarm once the high temperature alarm temperature is reached.</p>
	<p>"Ltd"</p> <p>Min. 0 min Max. 240 min Default 0 min</p>	<p>Alarm delay on low temperature alarm</p> <p>The number of minutes to wait before sounding an alarm once the low temperature alarm temperature is reached.</p>
	<p>"Pdd"</p> <p>Min. 0 min Max. 960 min Default 240 min</p>	<p>Pull down delay</p> <p>Normally, it is not necessary or desirable to sound an alarm during a pull down (the initial phase of reaching the desired temperature). This parameter prevents the high temperature alarm "HAt" sounding during pull down and after a defrost for the number of minutes set for the parameter. NOTE: it does not apply to the low temperature alarm "LAt".</p>
	<p>"dod"</p> <p>Min. 0 min Max. 60 min Default 2 min</p>	<p>Door Open delay</p> <p>It is possible to indicate to customers that a door has accidentally been left open. This parameter sets the delay in minutes before the alarm sounds. This is useful in environments where customers/users may hold the door open while making their selection. If the door is closed again before the set number of minutes is reached, the alarm does not sound. NOTE: a door sensor is required if this parameter is to be activated.</p>
	<p>"uAL"</p> <p>Min. no Max. yes Default no</p>	<p>Voltage alarm</p> <p>"no": no voltage alarm. "yES": voltage alarm activated.</p>
	<p>"LEA"</p> <p>Min. 0 hour Max. 96 hour Default 0 hour</p>	<p>Leakage alarm</p> <p>Leakage detection for compressor protection. "0": disable</p>
	<p>"Abd"</p> <p>Min. 0 min Max. 999 min Default 0 min</p>	<p>Alarm Buzzer Duration</p> <p>The alarm sounds for 10 seconds, followed by silence for 50 seconds. One alarm sequence therefore lasts 60 seconds. These values cannot be changed. This parameter determines how long in minutes an audible alarm will continue while there is still a reason to have an alarm. If set to 999, the alarm will continue to sound until the reason for the alarm is cleared – for example the temperature has dropped enough or the door closed. In some cases, it may be necessary for a user or technician to take action in order to clear the alarm. If set to 0, the alarm will never sound.</p>

<p>"ACA"</p> <p>Min. no Max. yes Default yes</p>	<p>Auto Clear of Alarm/Error/ACA</p> <p>If this parameter is set to "nO": The alarm status will not disappear automatically even if the condition which caused the alarm is no longer valid or present. If set to "yES": As soon as the condition which caused the alarm is no longer valid or present, the alarm status will automatically change back to inactive. There will be no trace of the alarm having occurred. In general, glass door merchandise applications will be set to "yES" and commercial fridges and freezers set to "nO". For example, if the temperature goes too high for a period there may be food safety considerations in a freezer containing food but not in a fridge with cold drinks.</p>	
<p>AHC Automatic Heater settings</p>		
	<p>Automatic Heater Control applies reverse cooling mode (heating) to your refrigeration appliance. This feature requires: A) that your appliance is exposed to ambient temperatures below the desired temperature in your cabinet (e.g. very cold climates and outdoor use). B) a special heater (for example a large defrost heater) built in to your appliance.</p>	
<p>"AuH"</p> <p>Min. no Max. yes Default no</p>	<p>Automatic Heater Mode Enable</p> <p>This setting is normally set to "no". When set to "yES", parameters "End" and "Hdi" apply.</p>	
<p>"End"</p> <p>Min. 0 min Max. 360 min Default 60 min</p>	<p>Energy Mode Delay</p> <p>This is the delay in minutes between the heater and the compressor operation. The heater is not allowed to start until this number of minutes has expired after the compressor has cut out and vice versa.</p>	
<p>"AHS"</p> <p>Min. -100.0°C Max. 200.0°C Default 2.0°C</p>	<p>Auto Heat set point</p> <p>Set point of auto heating.</p>	
<p>"Ahd"</p> <p>Min. 0.0 K Max. 20.0 K Default 2.0 K</p>	<p>Auto heat differential</p> <p>Thermostat differential for auto heating.</p>	
<p>ECS ECO strategy</p>		
	<p>NOTE: some of these parameters require the installation of the Danfoss Ambient Light Sensor. The Danfoss USB Gateway in combination with "Software tool" allows for real time measurement of the current light intensity. Danfoss recommends testing and adjusting "SLd" and "SLn" values according to customers' specific needs.</p>	
<p>"ECo"</p> <p>Min. no Max. yes Default Yes</p>	<p>ECO ON/OFF</p> <p>ECO active or not. If no all other settings are not active.</p>	
<p>"EdA"</p> <p>Min. 1 Max. 10 Default 1</p>	<p>Door Actions</p> <p>Times of door action to trigger exiting ECO (Can only be accessed by Danfoss)</p>	
<p>"EPA"</p> <p>Min. 1 Max. 10 Default 1</p>	<p>Pir Actions</p> <p>Times of "PIR" action to trigger exiting ECO (Can only be accessed by Danfoss).</p>	

	<p>"ECt"</p> <p>Min. 0 min Max. 180 min Default 30 min</p>	<p>Action counter time Door action or "PIR" action within action counter time can trigger exiting ECO (can only be accessed by Danfoss).</p>
	<p>"Edd"</p> <p>Min. 0 min Max. 180 min Default 180 min</p>	<p>Door delay Door delay after door close to trigger entering ECO (can only be accessed by Danfoss).</p>
	<p>"EPd"</p> <p>Min. 0 min Max. 180 min Default 120 min</p>	<p>Pir delay "PIR" delay to trigger entering ECO (can only be accessed by Danfoss).</p>
	<p>"SLd"</p> <p>Min. 0 Max. 80 Default 5</p>	<p>Shop Light Day/SLd Shop Light Night/SLn These parameters are set as the percentage of the maximum light and determine when the device moves into or out of ECO mode for power-saving purposes.</p>
	<p>"SLn"</p> <p>Min. 0 Max. 80 Default 3</p>	<p>"SLd" is the amount of ambient light which will cause the device to move to normal/serving mode from ECO mode (normally occurs in the morning). "SLn" is the amount of ambient light which will cause the device to move to ECO mode from normal/serving mode (normally occurs in the evening).</p>
	<p>"tto"</p> <p>Min. 0 hour Max. 168 hour Default 0 hour</p>	<p>Time to pull down Time which ERC stay in ECO and holiday mode to decide to enter pull down or serving mode.</p>
	<p>"LSD"</p> <p>Min. 0 min Max. 180 min Default 0 min</p>	<p>Light Source delay on ECO Time delay for light source to change from serving mode source to ECO mode source.</p>
	<p>"Euu"</p> <p>Min. no Max. yes Default yes</p>	<p>EWU active on/OFF Enable or disable early wake up.</p>
	<p>"CLH"</p> <p>Min. 0 hour Max. 24 hour Default 6 hour</p>	<p>Shop close hour Shop is assumed to be closed when staying in ECO mode longer than shop close hour.</p>
	<p>"ERL"</p> <p>Min. 0 min Max. 240 min Default 120 min</p>	<p>Early wake up time offset Time of exiting ECO mode for next day= Time of first activity to exit ECO mode - the early wake-up time. "0": early wake up function disabled."</p>
	<p>"HoL"</p> <p>Min. 0 hour Max. 999 hour Default 72 hour</p>	<p>Holiday Length In case that no activity has been registered for a number of days, specified by the holiday, the early-wake-up is deactivated and the cooler must stay in holiday mode until activity is detected.</p>
ECA		ECO management
	<p>"Eto"</p> <p>Min. -25.0 K Max. 25.0 K Default 4.0 K</p>	<p>Eco Temperature Offset This parameter gives a relative temperature in degrees. It is the difference in temperature for ECO mode operation compared to normal mode. NOTE: setting a temperature offset may be illegal in some jurisdictions.</p>
	<p>"Hto"</p> <p>Min. -25.0 K Max. 25.0 K Default 6.0 K</p>	<p>Holiday Temperature Offset Increase or decrease of temperature with respect to normal mode during holiday mode.</p>

	<p>"diE"</p> <p>Min. 0.0 K Max. 10.0 K Default 2.0 K</p>	<p>ECO Differential Thermostat differential for ECO.</p>
	<p>"FoE"</p> <p>Min. 0 s Max. 960 s Default 0 s</p>	<p>ECO Fan on cycle On time for fan during compressor OFF period in ECO mode.</p>
	<p>"FSE"</p> <p>Min. 0 s Max. 960 s Default 0 s</p>	<p>ECO Fan stop cycle OFF time for fan during compressor OFF period in ECO mode.</p>
	<p>"ELC"</p> <p>Default on</p>	<p>ECO Cabinet light control "on": always ON (Button is default to control light for all these options). "oFF": always OFF. "dor": door sensor only.</p>
	<p>"ELd"</p> <p>Min. 0 min Max. 10 min Default 5 min</p>	<p>Eco Light Delay This parameter causes a delay to the switch from normal to ECO mode when the shop lights are switched ON or OFF. The ambient light sensor detects the change in light level and causes a switch mode. With this parameter set to zero, the switch OFF mode occurs immediately. If not set to zero (max: 10 minutes), then the change will be delayed by the number of minutes set.</p>
<p>ASi Assignments settings</p>		
	<p>"uSA"</p> <p>Min. no Max. yes Default no</p>	<p>MODBUS Safety "on": MODBUS auto detection is enabled. "yES": MODBUS communication is deactivaed.</p>
	<p>"t1A"</p> <p>Min. -20.0 K Max. 20.0 K Default 0.0 K</p>	<p>Air Temperature Adjustment (applies to non-Danfoss temperature sensors only) This parameter is a relative value and allows adjustment of the control sensor temperature.</p>
	<p>"t2A"</p>	<p>For instance, at a measured temperature of 7°C and "tAd" set to -2 K, the input from the control sensor will be 5°C instead.</p>
	<p>"t3A"</p>	
	<p>"t4A"</p>	
		<p>Inputs and outputs are configurable There are two steps: 1. Define the type of sensor attached to the input: - temperature: light/digital. 2. Define the application for the sensor: - temperature: control/condenser/evaporator. - light: ECO/display/both. - motion - digital: door sensor. Please contact your local Danfoss representative for information about default settings. NOTE: coded sensors will impact on the number of possible configurations. For instance: Danfoss supplies only 2-pole defrost sensors, so input "S3" will most likely be used as a defrost/evaporator temperature sensor input.</p>

Default Stn	"S1C"	S1 Config/S1C S2 Config/S2C S3 Config/S3C
Default Stn	"S2C"	S4 Config/S4C S5 Config/S5C (remote display) S6 Config/S6C (remote display)
Default Stn	"S3C"	Available options are: "Stn": for a standard temperature sensor NTC 5 K @ 25°C and TPE precision. "Htn": for a high temperature sensor NTC 100 K @ 25°C.
Default Stn	"S4C"	"Pt1": for a temperature sensor Pt1000 ohm @ 0°C (only "S4"). "Ldr": for a light sensor (values given in Luminens). "dig": for a digital sensor with simple ON/OFF indication (motion, magnet, switch, button).
Default Stn	"S5C"	
Default Stn	"S6C"	
Default SCo	"S1A"	S1 Application/S1A S2 Application/S2A S3 Application/S3A S4 Application/S4A
Default nC	"S2A"	S5 Application/S5A S6 Application/S6A Available options are: "nC": not connected.
Default nC	"S3A"	"SCo": temperature control. "EuA": evaporator temperature. "Con": condenser temperature (Condenser cleaning).
Default nC	"S4A"	"AuS": only for showing temperature on display. "Ldr": light sensor, Luminens. "ECo": external input to control ECO mode. "doC": door contact, contact closed when door closed.
Default nC	"S5A"	"doo": door contact, contact open when door closed. "Pir": motion sensor (only "S3"). "bt5": button 5 (only "S4"). "rsp": remote spindle (only "S3").
Default nC	"S6A"	
Default non	"diC"	DI Config This is the digital input used for a digital sensor or bus communications. "non": not used. "doC": door contact, contact closed when door closed. "doo": door contact, contact open when door closed. "ECo": external input to control ECO mode. "Pir": motion sensor. Passive infrared.
Default CoP	"o1C"	D01 Config "CoP": direct compressor control. "PiC": pilot Relay (no zero cross) – if using pilot relay to control a compressor, this option must be used instead of "CoP". "HEt": heating application, inverse output. "PiH": pilot heat relay (no zero cross).

<p>"o2C" Default dEF</p>		<p>D02 Config/o2C D03 Config/o3C D04 Config/o4C D05 Config/o5C</p>																							
<p>"o3C" Default FAn</p>		<p>"no": not used. "dEF": electric defrost heater/valve for hot gas.</p>																							
<p>"o4C" Default Lig</p>		<p>"ALA": alamr output. "FAn": fan control. "Lig": light control.</p>																							
<p>"o5C" Default no</p>																									
<p>"b1C" Default noP</p>		<p>Lower left button: Button 1 Config (short press)/b1C Button 1 Config (long press)/b1L</p>	<p>The buttons can be programmed as follows:</p> <table border="1"> <thead> <tr> <th>Short press function</th> <th>Long press function</th> </tr> </thead> <tbody> <tr> <td>"noP": not operating</td> <td>"noP": not operating</td> </tr> <tr> <td>"tP": increase set point</td> <td>"tP": increase set point</td> </tr> <tr> <td>"tn": decrease set point</td> <td>"tn": decrease set point</td> </tr> <tr> <td>"ECo": toggle Eco mode</td> <td>"ECo": toggle Eco mode</td> </tr> <tr> <td>"Lig": toggle light</td> <td>"Lig": toggle light</td> </tr> <tr> <td>"dEF": toggle defrost</td> <td>"dEF": toggle defrost</td> </tr> <tr> <td>"SuP": toggle super-cool/pull down</td> <td>"SuP": toggle super-cool/pull down</td> </tr> <tr> <td>"diP": increase display intensity</td> <td>"diP": increase display intensity</td> </tr> <tr> <td>"din": decrease display intensity</td> <td>"din": decrease display intensity</td> </tr> <tr> <td>"CFA": toggle °C and °F</td> <td>"CFA": toggle °C and °F</td> </tr> </tbody> </table>	Short press function	Long press function	"noP": not operating	"noP": not operating	"tP": increase set point	"tP": increase set point	"tn": decrease set point	"tn": decrease set point	"ECo": toggle Eco mode	"ECo": toggle Eco mode	"Lig": toggle light	"Lig": toggle light	"dEF": toggle defrost	"dEF": toggle defrost	"SuP": toggle super-cool/pull down	"SuP": toggle super-cool/pull down	"diP": increase display intensity	"diP": increase display intensity	"din": decrease display intensity	"din": decrease display intensity	"CFA": toggle °C and °F	"CFA": toggle °C and °F
Short press function	Long press function																								
"noP": not operating	"noP": not operating																								
"tP": increase set point	"tP": increase set point																								
"tn": decrease set point	"tn": decrease set point																								
"ECo": toggle Eco mode	"ECo": toggle Eco mode																								
"Lig": toggle light	"Lig": toggle light																								
"dEF": toggle defrost	"dEF": toggle defrost																								
"SuP": toggle super-cool/pull down	"SuP": toggle super-cool/pull down																								
"diP": increase display intensity	"diP": increase display intensity																								
"din": decrease display intensity	"din": decrease display intensity																								
"CFA": toggle °C and °F	"CFA": toggle °C and °F																								
<p>"b1L" Default PoF</p>		<p>Upper left button: Button 2 Config (short press)/b2C Button 2 Config (long press)/b2L</p>																							
<p>"b2C" Default dEF</p>		<p>Upper right button: Button 3 Config (short press)/b3C Button 3 config (long press)/b3L</p>																							
<p>"b2L" Default inF</p>																									
<p>"b3C" Default tP</p>		<p>Lower right button: Button 4 Config (short press)/b4C Button 4 Config (long press)/b4L</p>	<p>NOTE: Your assignments may not be shown on the printed buttons. We advice to use this functionality together with the fully integrated mounting model only.</p>																						
<p>"b3L" Default ECo</p>																									
<p>"b4C" Default tn</p>																									
<p>"b4L" Default Lig</p>																									
<p>"b5C" Default noP</p>		<p>Button 5 Config (short press) / b5C Button 5 Config (long press) / b5L</p>	<table border="1"> <thead> <tr> <th>Short press function</th> <th>Long Press function</th> </tr> </thead> <tbody> <tr> <td>"noP": not operating</td> <td>"noP": Not operating</td> </tr> <tr> <td>"ECo": toggle ECO mode</td> <td>"ECo": Toggle Eco mode</td> </tr> <tr> <td>"SuP": toggle super-cool/pull down</td> <td>"SuP": Toggle Super-Cool /Pull-down</td> </tr> <tr> <td>"Lig": toggle light</td> <td>"Lig": Toggle light</td> </tr> <tr> <td>"dEF": toggle defrost</td> <td>"dEF": Toggle defrost</td> </tr> <tr> <td></td> <td>"PoF": ERC power ON/OFF</td> </tr> <tr> <td></td> <td>"HoL": enter holiday mode</td> </tr> </tbody> </table>	Short press function	Long Press function	"noP": not operating	"noP": Not operating	"ECo": toggle ECO mode	"ECo": Toggle Eco mode	"SuP": toggle super-cool/pull down	"SuP": Toggle Super-Cool /Pull-down	"Lig": toggle light	"Lig": Toggle light	"dEF": toggle defrost	"dEF": Toggle defrost		"PoF": ERC power ON/OFF		"HoL": enter holiday mode						
Short press function	Long Press function																								
"noP": not operating	"noP": Not operating																								
"ECo": toggle ECO mode	"ECo": Toggle Eco mode																								
"SuP": toggle super-cool/pull down	"SuP": Toggle Super-Cool /Pull-down																								
"Lig": toggle light	"Lig": Toggle light																								
"dEF": toggle defrost	"dEF": Toggle defrost																								
	"PoF": ERC power ON/OFF																								
	"HoL": enter holiday mode																								
<p>"b5L" Default noP</p>																									
<p>"PS1" Min. 0 Max. 999 Default 0</p>		<p>Password level 1 / PS1 Password Level 2 / PS2 Password Level 3 / PS3</p>																							
<p>"PS2" Min. 0 Max. 999 Default 0</p>		<p>These assign passwords to the three levels of access. The password is a three-digit number. Access levels are Shop, Service and OEM.</p>																							
<p>"PS3" Min. 0 Max. 999 Default 0</p>		<p>You may not therefore have access to change all the passwords. Passwords are entered by using the up and down arrow buttons. Danfoss advises against using passwords which are easy to remember or enter, for example 111, 222, 123 etc.</p>																							
<p>"PS3" Min. 0 Max. 999 Default 0</p>		<p>NOTE: When accessing the controller with 3 wrong password in a sequence ERC will automatically block access for 15 minutes.</p>																							

Ser		Service information settings
		<p>The parameters in the following section are READ ONLY and cannot be changed by the user. They provide information for technicians and OEM users.</p> <p>NOTE: the only parameters that can be configured are: "oEL", "oEn", "oEH". These parameters allow OEMs to enter their own product code.</p>
	"ACt"	Accumulated Comp. run time
	"AFt"	Accumulated Fan run time
	"ALt"	Accumulated Light run time
	"AEt"	Accumulated ERC up time
	"Sd"	DI physical DI pin state (ON; OFF).
	"uAC"	Voltage value Current main power supply voltage.
	"ouS"	DOs Status Current relay open closed status. "////" = all relay ON (Upper bar for on, Lower bar for OFF). "///" = DO1 ON, DO2 OFF, DO3 & DO4 NA (no bar if relay not mounted). "////" = all relay OFF (Upper bar for on, Lower bar for OFF).
	"rL1"	Relay 1 counter Thousands of cycles of compressor relay since manufacture.
	"rL2"	Relay 2 counter Thousands of cycles of no. 2 relay since manufacture.
	"rL3"	Relay 3 counter Thousands of cycles of no. 3 relay since manufacture.
	"rL4"	Relay 4 counter Thousands of cycles of no. 4 relay since manufacture.
	"rL5"	Relay 5 counter Thousands of cycles of no. 5 relay since manufacture.
	"int"	Interval Counter Compressor run time since last defrost.
	"dnt"	Defrost time counter Duration of last defrost cycle [min].
	"ont"	Door open counter "ont/100"=number of door openings since last reset.
	"Snu"	Serial number Serial number given at manufacturing.
	"Fir"	SW version Danfoss software version number.
	"HAr"	HW version Danfoss hardware version number.
	"onL"	OrderNoLow Danfoss order code number.
	"onH"	OrderNoHigh Danfoss order code number.
	"oEL"	OEM code Low

"oEn"	OEM code Middle
"oEH"	OEM code High
"PAr"	Parameter version OEM parameter version number [requires EKA copy key update].
"CHd"	Manufacturing date Programme date WWY: week number and year number (2010-19).
"SFC"	Set as Default Resets all parameters to last good OEM settings.
"CtT"	Condenser Temp Temperature of the condensor sensor.
"Et1"	Evaporator1 Temp Temperature of the evaporator sensor1.
"Et2"	Evaporator2 Temp Temperature of the evaporator sensor2.
"AuS"	AUX Temp. Temperature of the AUX sensor. invisible.
"LLu"	Light level value Actual light level value from light sensor.
"Pir"	Motion sensor state
"atT"	Raw Sair Temp
"ESS"	External ECO switch state
	Display messages
"unP"	Device is unprogrammed (relay output is lockt)
"Prg"	Device has not finished programming (relay output is lockt)
"Eco"	Device is in Eco mode
"SC"	Device is in pull-down mode (super-chill)
"dEF"	Device is defrosting
"HoL"	Device is in Holiday mode

Troubleshooting

Problem	Probable cause	Remedy
Compressor does not start	Waiting for compressor delay timer Defrost in progress Line voltage to compressor too low or too high	Check CoP->CSt Check CoP ->Pot /Pod Check dEF ->dit, dot Check CoP->uLi, uLo, uHi
Fan does not start	Door is open or door contact is defective	Fan stops when door is opened Check that door contact is ok
Defrost does not start	Controller in pull down mode	Defrost might be delayed during pull down Check parameter Pud->Pdi
Alarm does not sound	Alarm delayed	Check ALA->Htd, Abd Check Pud->Pdd
Display brightness is weak	Ambient light sensor broken	Replace sensor
Shift between ECO and normal mode does not happen on ambient light change	Ambient light sensor broken or light level not set properly	Check Eng->SLd, SLn
Display alternates between condenser and temperature	Condenser too hot	Clean condenser Check Con ->CAL, CbL
Display alternates between high and temperature	Temperature too high	Check ALA->HAt
Display alternates between low and temperature	Temperature too low	Check ALA -> LAT
Display shows "dEf"	Defrost in progress	Check diS ->SdF

Alarm code	Trigger	Automatic clearance	Outputs	Comments
"Hi"	Air temperature is higher than "ALA->Hat" for "ALA->Htd"	User configured	Blink "Hi" with the highest temperature; If configured: cut in alarm relay, beep the buzzer	High temperature alarm
"Lo"	Air temperature is lower than "LAT" for "Ltd"	User configured	Blink "Lo" with the lowest temperature. If configured: cut in alarm relay, beep the buzzer	Low temperature alarm
"Con"	Condenser temperature is too high or too low	User configured	Blink "Con". If configured: cut in alarm relay, beep the buzzer	Condenser alarm
"dor"	Door open for more than "ALA -> dod"	Always	Blink "dor". If configured: cut in alarm relay, beep the buzzer	Door open alarm
"uHi"	Line voltage is higher than "Cop->uHi"	Always	Blink "uHi". If configured: cut in alarm relay, beep the buzzer	High voltage alarm
"uLi"	Line voltage is lower than "Cop->uLi"	Always	Blink "uLo". If configured: cut in alarm relay, beep the buzzer.	Low voltage alarm
"LEA"	Compressor continuous running for more than "ALA->LEA"	Always	Blink "LEA". If configured: cut in alarm relay, beep the buzzer	Leakage alarm
"E01"	"S1" error	Always	Blink "E01". If configured: cut in alarm relay, beep the buzzer	"S1" sensor failure (short or open)
"E02"	"S2" error	Always	Blink "E02". If configured: cut in alarm relay, beep the buzzer	"S2" sensor failure (short or open)
"E03"	"S3" error	Always	Blink "E03". If configured: cut in alarm relay, beep the buzzer	"S3" sensor failure (short or open)
"E04"	"S4" error	Always	Blink "E04". If configured: cut in alarm relay, beep the buzzer	"S4" sensor failure (short or open)

Technical specs

Power Supply	100 - 240 VAC (±10%), switch mode power supply		
Rated Power	Average 0.7 W		
	5 Inputs: 4 Analogue & Digital, 1 Digital; user specific assignment		
Input	• Air/Evaporator/Condenser	• Door sensor: all types, user specific	• Motion sensor
	• Light sensor: Danfoss ECO light sensor	• DP: for remote communication	
Output		UL60730	EN60730
	"DO1" (Compressor relay)	120 V a.c.: 16 A resistive/FLA16/LRA72 240 V a.c.: 10 A resistive/FLA10/LRA60	16(16) A
	"DO4"	8 A resistive, FLA2/LRA12, TV-1	8 A resistive, 2(2) A
	"DO5"	FLA2/LRA12, TV-1	8 A resistive, 2(2) A
	"DO6"	FLA2/LRA12, TV-1	8 A resistive, 2(2) A
			Max 10 A total "DO4-6"
Probes	Danfoss NTC sensors and Danfoss ECO accessories (300 - 3,000 mm) Danfoss PT1000 ohm/0°C		
Connectors	Modular connector system for OEM customers, with optional output screw terminal adapter; Input connector type: Rast2.5 Edge connectors; Output connector type: RAST 5 Standard		
Programming	Programming with Danfoss ERC docking station, integrated system		
Assembly	Self-drilling screws or plastic quick fasteners		
Keypad	Only with RDI 107: 4 buttons (integrated IP65 design), 2 left, 2 right; user programmable		
Operating Conditions	0 °C to 55 °C, 93% rH		
Storage Conditions	-40 °C to 85 °C, 93% rH		
Range of Measurement	-40 °C to 85 °C		
Protection	Water and dust protection corresponds to IP31, accessibility of connectors limit rear part rating to IP00		
Environmental	Pollution degree II, non-condensing		
Resistance to heat & fire	Category D (UL94-V0)		
EMC category	Category I		
Operating Cycles	Compressor relay: more than 175,000 at full load (16A(16A))		
Approvals	R290/R600a end-use applications employing in accordance to EN/IEC 60335-2-24, annex CC and EN/IEC 60335-2-89, annex BB Glow wire according to EN/IEC 60335-1 IEC/EN 60730 UL60730 NSF GOST R 60730	These approvals are only valid when using the accessories approved	

Dimensions

ERC 113

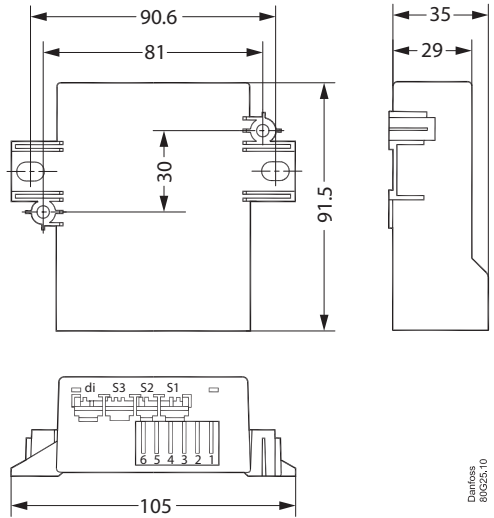

Danfoss
806258,10

Remote spindle

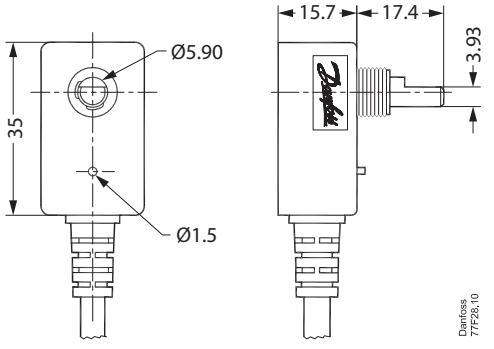

Danfoss
77F28,10

Remote display

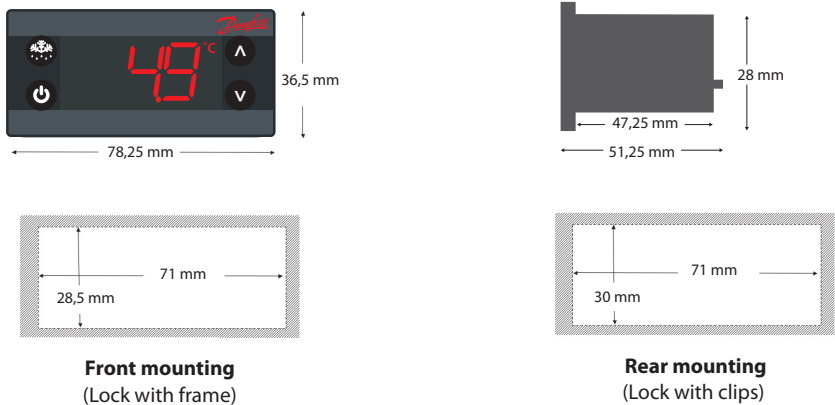

Front mounting
(Lock with frame)

Rear mounting
(Lock with clips)

Code numbers

Type	Code no. I-Pack
ERC 113 stand alone	
ERC 113A	080G3250
ERC 113B	080G3251
ERC 113C	080G3252
ERC 113D	080G3253
Remote display GDM front	
RDI 107 RED LED	080G3240
RDI 107 BLUE LED	080G3241
Remote display CFF front (with buzzer)	
RDI 107 RED LED	080G3245
RDI 107 BLUE LED	080G3246
Remote spindle	
RSP 01, 1000 mmm, 3-pole	080G3371
RSP 01, 2000 mmm, 3-pole	080G3373
RSP 01, 3000 mmm, 3-pole	080G3375
Temperature sensors	
<i>-40 — 85 °C, PVC Standard, NTC 5 K</i>	
S1, 470 mm, 3-pole	077F8751
S1, 1000 mm, 3-pole	077F8757
S1, 1500 mm, 3-pole	077F8761
S1, 2000 mm, 3-pole	077F8765
S1, 2200 mm, 3-pole	077F8767
S1, 3000 mm, 3-pole	077F8769
S1, 3500 mm, 3-pole	077F8723
S1, 6000 mm, 3-pole	080G2019
<i>-40 — 120 °C, TPE precision NTC 5 K, Santroprene</i>	
S1, 1500 mm, 3-pole	077F8726
S1, 2000 mm, 3-pole	077F8727
S1, 3000 mm, 3-pole	077F8729
<i>-20 — 175 °C, Silicone rubber cable, NTC 100 K</i>	
S1/S3, 1000 mm, 3-pole	080G2041
S1/S3, 2000 mm, 3-pole	080G2043
S1/S3, 3000 mm, 3-pole	080G2045
<i>-40 — 85 °C, PVC Standard, NTC 5 K</i>	
S2, 1000 mm, 2-pole	077F8786
S2, 1500 mm, 2-pole	077F8790
S2, 2000 mm, 2-pole	077F8794
S2, 3000 mm, 2-pole	077F8798
S2, 6000 mm, 2-pole	080G2029
S3, 1000 mm, 3-pole	077F8756
S3, 1500 mm, 3-pole	077F8760

Type	Code no. I-Pack
S3, 2200 mm, 3-pole	077F8766
S3, 3000 mm, 3-pole	077F8768
S3, 6000 mm, 3-pole	080G2039
<i>-100 — 200 °C, Pt 1000</i>	
S4, 1000 mm, 3-pole	080G3350
S4, 2000 mm, 3-pole	080G3351
S4, 3000 mm, 3-pole	080G3352
Light-sensors	
S3, 1000 mm, 3-pole	080G3311
S3, 2000 mm, 3-pole	080G3313
S3, 3000 mm, 3-pole	080G3315
Magnetic door sensor	
di/S4, 1000 mm, 3-pole	080G3320
di/S4, 2000 mm, 3-pole	080G3322
di/S4, 3000 mm, 3-pole	080G3324
Cable door sensor	
di/S4, 1000 mm, 3-pole	080G3340
di/S4, 2000 mm, 3-pole	080G3341
di/S4, 3000 mm, 3-pole	080G3342
di/S4, 4000 mm, 3-pole	080G3343
Motion sensor	
S3/di, 1000 mm, 3-pole	080G3390
S3/di, 2000 mm, 3-pole	080G3391
S3/di, 3000 mm, 3-pole	080G3392
S3/di, 4000 mm, 3-pole	080G3393
Communication Wire	
RD Comm. wire, 1000 mm, 3 pole	080G3381
RD Comm. wire, 2000 mm, 3 pole	080G3383
RD Comm. wire, 3000 mm, 3 pole	080G3385
Clips	
Black (2 needed per controller)	080G3308
Programming	
OEM Docking station, product. line	080G9701
Gateway incl USB Cable, R&D	080G9711
Programming key EKA183A	080G9740
Power plug *	
3-pole with screw	080G3364
6-pole with screw	080G3365

* Available optional plugs with screw connections are limited to 10 A

Note: For more information about temperature sensor types and connectors, please refer to Danfoss' technical brochure "NTC type temperature sensors for ETC & ERC controllers".

Typical applications

No-frost freezer/sub-zero cooler

Temperature Sensor for Cabinet Temperature Control	
PVC Standard Connector type (S1) 3-pole	
470 mm	077F8751
1000 mm	077F8757
1500 mm	077F8761
2000 mm	077F8765
2200 mm	077F8767
3000 mm	077F8769
3500 mm	077F8723
6000 mm	080G2019

Temperature Sensor for Evaporator Temperature Control	
PVC Standard Connector type (S2) 2-pole	
1000 mm	077F8786
1500 mm	077F8790
2000 mm	077F8794
3000 mm	077F8798
6000 mm	080G2029

Remote spindle	
Remote spindle	
1000 mm	080G3371
2000 mm	080G3373
3000 mm	080G3375

Door input			
Door sensor cable di/S4 3-pole		Magnetic door sensor di/S4 3-pole	
1000 mm	080G3340	1000 mm	080G3320
2000 mm	080G3341	2000 mm	080G3322
3000 mm	080G3342	3000 mm	080G3324
4000 mm	080G3343		

ERC 113D	
Controller	080G3253

Glass door merchandiser

Temperature Sensor for Cabinet Temperature Control	
PVC Standard Connector type (S1) 3-pole	
470 mm	077F8751
1000 mm	077F8757
1500 mm	077F8761
2000 mm	077F8765
2200 mm	077F8767
3000 mm	077F8769
3500 mm	077F8723
6000 mm	080G2019

Temperature Sensor for Evaporator Temperature Control	
PVC Standard Connector type (S2) 2-pole	
1000 mm	077F8786
1500 mm	077F8790
2000 mm	077F8794
3000 mm	077F8798
6000 mm	080G2029

Remote spindle	
Remote spindle	
1000 mm	080G3371
2000 mm	080G3373
3000 mm	080G3375

Door input			
Door sensor cable di/S4 3-pole		Magnetic door sensor di/S4 3-pole	
1000 mm	080G3340	1000 mm	080G3320
2000 mm	080G3341	2000 mm	080G3322
3000 mm	080G3342	3000 mm	080G3324
4000 mm	080G3343		

ERC 113C	
Controller	080G3252

No-frost freezer/sub-zero cooler

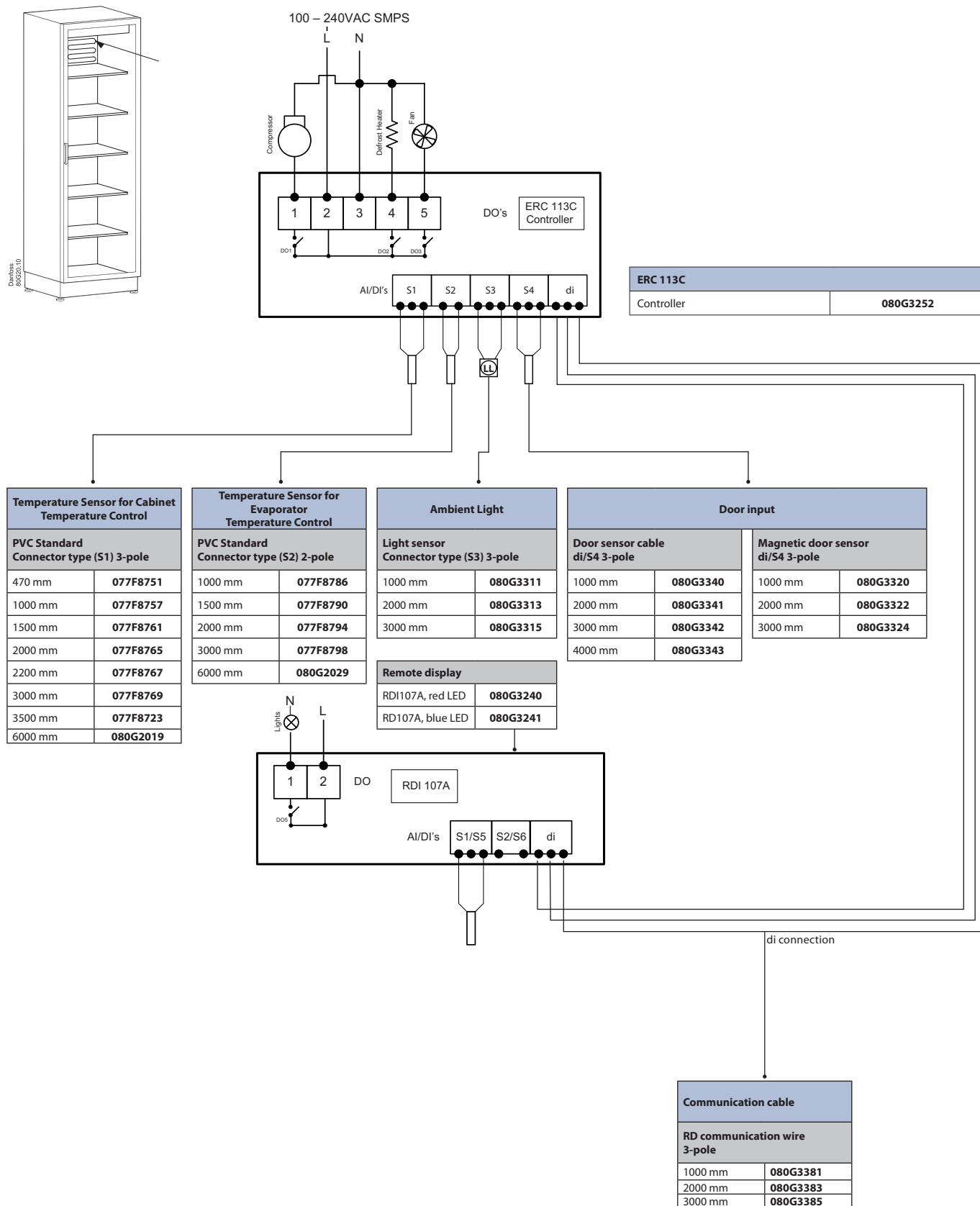

Sensor placement

Control sensor

The control sensor must always be connected and is used for controlling the cut-in and cut-out of the compressor according to the set point. The sensor is also used for the displayed temperature.

Control sensor

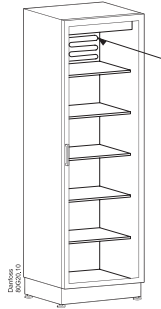

Vertical coolers with fan

Most common placement is in the return air to the evaporator. The sensor can be placed close to the fan – even when the fan is pulsed during compressor OFF periods: the updating of the temperature is blocked when the fan is stopped and only updated when the fan has been running for a while, so that the heat from the fan does not affect the temperature reading.

For applications sensitive to sub-zero temperatures, sensor placement in the evaporator outlet air can be considered.

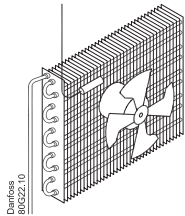

Vertical freezers with fan

Placement in the return air or in the freezer compartment.

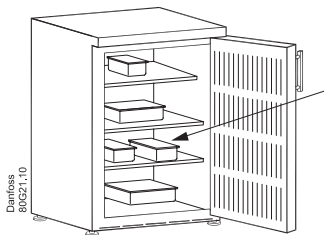

Coolers without fan

The best results are normally obtained when the sensor is placed at the side-wall, 10 cm from the back and approximately at 1/3 from the bottom or where the evaporator ends.

The control sensor must always be connected and is used for controlling the cut-in and cut-out of the compressor according to the set point. The sensor is also used for the displayed temperature.

Evaporator sensor

The evaporator sensor is only used for de-icing of the evaporator and has no control purpose.

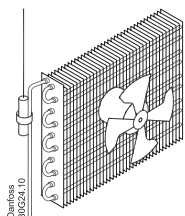

Placement of sensor

Place the sensor where the ice melts last. Please be aware of that sharp fins can damage the cable.

Condenser sensor

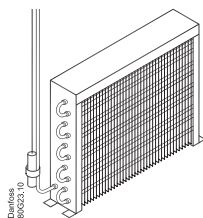

The condenser sensor is used to protect the compressor against high pressure when the condenser is blocked or the condenser fan fails.

Placement of sensor

Place the sensor at the liquid side of the condenser. Use a metal bracket or metal tape to ensure good thermal conductivity. Be sure that the cable does not pass hot spots at the compressor or condenser that exceeds 80°C.

Ambient light sensor

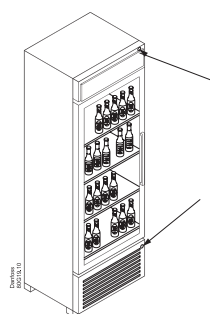

The ambient light sensor is used to detect opening hours of the shop.

Placement of sensor

The sensor must be placed so that the interior light does not affect the sensor. Possible placement could be in the front of the cooler or at the top.

Door sensor

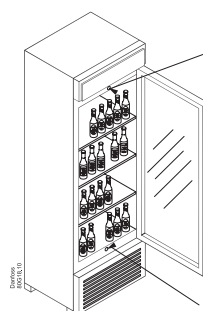

The door sensor is used to detect buying activity and to stop the fan when the door is opened.

Door sensor

Danfoss does not supply the door-switch. Use the door-switch you have and connect it to the cable supplied by Danfoss.

Application matrix

Stand-alone		Output				Input			
Application	ERC type	DO1	DO2	DO3	DO4	S1 (C1)	S2 (C2)	S3 (C3)	Di (C4)
Standard beverage cooler	ERC 113C	Comp	Fan	Lamp		Control	Defrost	Condenser or ambient light	Door
Sub-zero beverage cooler	ERC 113D	Comp	Heater	Fan	Lamp	Control	Defrost	Condenser or ambient light	Door
Out-door beverage cooler	ERC 113D	Comp	Heater	Fan	Lamp	Control	Condenser	Ambient light	Door
No frost freezer w. glass-door	ERC 113D	Comp	Heater	Fan	Lamp	Control	Defrost	Condenser or ambient light	Door
CFF refrigerator	ERC 113C	Comp	Fan	Lamp		Control	Defrost	Condenser	Door
CFF freezer	ERC 113D	Comp	Heater	Fan	Lamp	Control	Defrost	Condenser	Door

NOTE:

- select only one function per input, e.g. condenser sensor or ambient light sensor
- make sure that the accessory you select has a matching connector to the input, e.g. a sensor for input S2 must have C2 connector
- condenser sensor or light sensor are optional and can be omitted
- defrost sensor is mandatory when electrical heater is used for defrost. For natural defrost it can be omitted

Remote display		Output					Input					
Application	ERC type	DO1	DO2	DO3	DO4	DO5	S1 (C1)	S2 (C2)	S3 (C3)	Di (C4)	S4 (C1)	S5 (C2)
Standard beverage cooler	ERC 113C	Comp	Fan	Lamp			Control	Condenser	Ambient light	RD107	Defrost	Door
Sub-zero beverage cooler	ERC 113D	Comp	Heater	Fan	Lamp		Control	Condenser	Ambient light	RD107	Defrost	Door
Out-door beverage cooler	ERC 113D	Comp	Heater	Fan	Lamp		Control	Condenser	Ambient light	RD107	Defrost	Door
No frost freezer w. glass-door	ERC 113D	Comp	Heater	Fan	Lamp		Control	Condenser	Ambient light	RD107	Defrost	Door
CFF refrigerator	ERC 113C	Comp	Fan	Lamp			Control	Condenser	Ambient light	RD107	Defrost	Door
CFF freezer	ERC 113D	Comp	Heater	Fan	Lamp		Control	Condenser	Ambient light	RD107	Defrost	Door

NOTE:

- select only one function per input, e.g. condenser sensor or ambient light sensor
- any input at RD107 can be chosen for control, defrost, condenser, ambient light or door, if it is more convenient for cable routing
- make sure that the accessory you select has a matching connector to the input, e.g. a sensor for input S2 or S5 must have C2 connector
- condenser sensor or light sensor are optional and can be omitted
- defrost sensor is mandatory when electrical heater is used for defrost. For natural defrost it can be omitted
- the relay in RDI07A (DO5) can be used for heater, fan, lamp or alarm, and can be used instead of DO2 - DO4

Remote spindle		Output				Input			
Application	ERC type	DO1	DO2	DO3	DO4	S1 (C1)	S2 (C2)	S3 (C3)	Di (C4)
Standard beverage cooler	ERC 113C	Comp	Fan	Lamp		Control	Condenser or ambient light	RSP01	Door
Sub-zero beverage cooler	ERC 113D	Comp	Heater	Fan	Lamp	Control	Defrost	RSP01	Door
Out-door beverage cooler	ERC 113D	Comp	Heater	Fan	Lamp	Control	Condenser or ambient light	RSP01	Door
No frost freezer w. glass-door	ERC 113D	Comp	Heater	Fan	Lamp	Control	Defrost	RSP01	Door
CFF refrigerator	ERC 113C	Comp	Fan	Lamp		Control	Defrost or condenser	RSP01	Door
CFF freezer	ERC 113D	Comp	Heater	Fan	Lamp	Control	Defrost	RSP01	Door

NOTE:

- select only one function per input, e.g. condenser sensor or ambient light sensor
- make sure that the accessory you select has a matching connector to the input, e.g. a sensor for input S2 must have C2 connector
- condenser sensor or light sensor are optional and can be omitted
- defrost sensor is mandatory when electrical heater is used for defrost. For natural defrost it can be omitted

