



Programmable Electronic Thermostat

2 Heat/2 Cool, 7-Day Programmable, Hardwired
Daikin P/N (668375301)



- Programmable and Configurable
- Single/Dual Stage Heat/Cool Systems
- Backlit Display
- Auto Changeover
- SimpleSet® 7 Day Programming
- Title 24 Compliant/No Batteries Required
- Relay Outputs (minimum voltage drop in thermostat)
- Ideally Suited for:
 - Light Commercial/Residential (New Construction/ Replacement)

Installation, Operation & Application Guide



Version B: 10-15-13

Specifications

- Electrical rating:** • 24 VAC/VDC (18-30 VAC/VDC)
• 1 amp maximum per terminal
• 4 amp maximum total load
- Temperature control range:** 45°F to 90°F (7°C to 32°C) **Accuracy:** ± 1°F (± 0.5°C)
- System configurations:** 2-stage heat, 2-stage cool
- Terminations:** -C, +R, W1, Y1, W2, Y2, G, S1, S2

Important Safety Information

WARNING! Always turn off power at the main power supply before installing, cleaning, or removing thermostat.

- This thermostat is for 24 VAC/VDC applications only; do not use on voltages over 30 VAC/VDC
- Do not short across terminals of gas valve or system control to test operation; this will damage your thermostat and void your warranty
- All wiring must conform to local and national electrical and building codes
- Do not use air conditioning when the outdoor temperature is below 50 degrees; this can damage your A/C system and cause personal injuries

Package Contents/Tools Required

Daikin programmable thermostat on base, labeled thermostat cover, wiring labels, screws and wall anchors, Owner's Manual, Installation, Operation and Application Guide.

Drill with 3/16" bit, hammer, screwdriver.

To Remove Existing Thermostat

ELECTRICAL SHOCK HAZARD – Turn off power at the main service panel by removing the fuse or switching the appropriate circuit breaker to the OFF position before removing the existing thermostat.

1. Turn off power to the heating and cooling system by removing the fuse or switching the appropriate circuit breaker off.
2. Remove cover of old thermostat. This should expose the wires.
3. Label the existing wires with the enclosed wire labels before removing wires.
4. After labeling wires, remove wires from wire terminals.
5. Remove existing thermostat base from wall.
6. Refer to the following section for instructions on how to install this thermostat.

To Install Thermostat

ELECTRICAL SHOCK HAZARD – Turn off power at the main service panel by removing the fuse or switching the appropriate circuit breaker to the OFF position before removing the existing thermostat.

IMPORTANT:Note:

2. To remove cover, insert and twist a coin or screwdriver in the slots on the sides of the thermostat.
3. Put thermostat base against the wall where you plan to mount it (Be sure wires will feed through the wire opening in the base of the thermostat).
4. Mark the placement of the mounting holes.
5. Set thermostat base and cover away from working area.
6. Using a 3/16" drill bit, drill holes in the places you have marked for mounting.
7. Use a hammer to tap supplied anchors in mounting holes.
8. Align thermostat base with mounting holes and feed the control wires through wire opening.
9. Use supplied screws to mount thermostat base to wall.
10. Insert stripped, labeled wires in matching wire terminals. See "Wiring Diagrams" section of this manual. If using optional remote sensor, see "Remote Sensor Installation".
- CAUTION!** Be sure exposed portion of wires does not touch other wires.
11. Tighten screws on terminal block. Gently tug wire to be sure of proper connection. Double check that each wire is connected to the proper terminal.
12. Seal hole for wires behind thermostat with non-flammable insulation or putty.
13. Replace cover on thermostat by snapping it in place.
14. Turn on power to the system at the main service panel.
15. Test thermostat operation as described in "Testing the Thermostat".

Remote Sensor Installation (Optional)

Requires Daikin Remote Sensor Part Number 667720401

1. Remove cover from remote sensor housing.
2. Select an appropriate location for mounting the remote sensor.
3. Mount remote sensor unit using hardware provided.
4. Install two strand shielded wire between remote sensor and thermostat. Shielded wire must be used. Do not run remote sensor wire in conduit with other wires.
 - **Wire 1** should run between the S1 terminal on the thermostat and the S1 terminal on the remote sensor
 - **Wire 2** should run between the S2 terminal on the thermostat and the S2 terminal on the remote sensor
 - Connect the shielding of the wire to the S2 terminal on the thermostat
5. Disable the main sensor (R12) on the thermostat by cutting it from the circuit board.

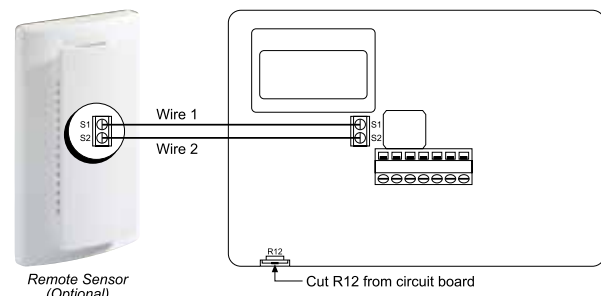

Wiring Diagram

Two-Stage Heat/Two-Stage Cool, 7-Day Programmable (Part No. 668375301)

MicroTech III Unit Control Board
Low Voltage Terminal Strip (Circuit 1)

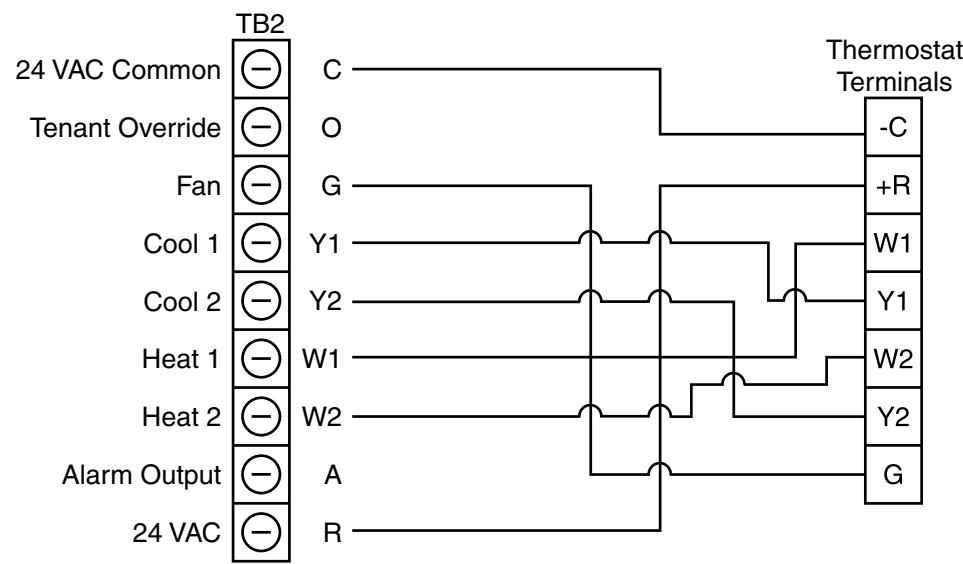

Note: Includes Thermostat and Wall Plate.

Terminal Designator Descriptions

-C – 24 VAC/VDC common	W1 – 1st stage heat	W2 – 2nd stage heat	G – Fan
+R – 24 VAC/VDC hot	Y1 – 1st stage cool	Y2 – 2nd stage cooling	

Configuration Mode

The configuration mode is used to set the SC3801 to match your heating/cooling system. The SC3801 functions with heat pump, air conditioning, gas, oil, or electric heat systems.

1. To enter the configuration mode, simultaneously hold down the \vee and \wedge buttons while the SC3801 is in OFF mode.
2. Press the \vee or \wedge button to change settings within each screen.
3. Press the \gt button to advance to the next screen.
- * **Note:** The \lt button will return you to the previous screen.
4. To exit configuration mode, hold in the \gt button for 6 seconds.

Configuration Mode Settings

The setup screens for configuration mode are as follows:

1. Heat pump – Press the \vee or \wedge button to configure as heat pump or non-heat pump system.
 - ON = Heat pump system
 - OFF = Non-heat pump system
 Press the \gt button to advance to the next screen.
2. Reversing valve – appears only if heat pump is set to "ON". Press the \vee or \wedge button to set reversing valve. If your reversing valve is energized in heat mode, set to "b." If the reversing valve is energized in cool mode, set to "o." Press the \gt button to advance to the next screen.
3. HEAT, ELECTRIC, or GAS/OIL – appears only if heat pump setting is "OFF". Press the \vee or \wedge button to set heat type.
 - For electric heat (interlocked), set "ELC" ON
 - For gas or oil heat (non-interlocked), toggle "ELC" OFF
 Press the \gt button to advance to the next screen.
4. Temperature scale (F or C) – Choose Fahrenheit or Celsius. Press the \vee or \wedge button to select. Press the \gt button to advance to the next screen.
5. Stage 1 Differential (1°F to 3°F) (1°C to 2°C) – Set the number of degrees between your "turn on" temperature and your "setpoint" temperature. Press the \vee or \wedge button to set differential value. Press the \gt button to advance to the next screen.
6. Stage 2 Differential (1°F to 6°F) (1°C to 3°C) – Set the number of degrees between when Stage 1 turns on and when Stage 2 turns on. Press the \vee or \wedge button to set differential value. Press the \gt button to advance to the next screen.
7. Deadband (1°F to 9°F) (1°C to 5°C) – Set the minimum number of degrees between your heating system activation and your cooling system activation. Press the \vee or \wedge button to set deadband value. Press the \gt button to advance to the next screen.
8. Staged off outputs – Select whether the outputs for heating and cooling are staged off independently or are satisfied simultaneously.
 - 1 = Economy Mode – Outputs are staged on and off in accordance with setpoint and differential.
 - 0 = Comfort Mode – Outputs are staged on and all stages cycle off simultaneously when set point is satisfied.
 Press the \vee or \wedge button to select. Press the \gt button to advance to the next screen.
9. Fan ON Delay – HEAT cycle (0-120 seconds) – Time fan is delayed turning ON at start of heat cycle. For no delay, set to 0:00 (appears only for heat pump or electric heat systems). Press the \vee or \wedge button to set delay. **CAUTION!** Changing from the default of 0:00 may permanently damage your system. Press the \gt button to advance to the next screen.
10. Fan OFF Delay – HEAT cycle (0-240 seconds) – Time fan is delayed turning OFF after heat cycle. For no delay, set to 0:00. ***Note:** This appears only for heat pump or electric heat systems. Press the \vee or \wedge button to set delay. **CAUTION!** Changing from the default of 0:00 may permanently damage your system. Press the \gt button to advance to the next screen.
11. Fan ON Delay – COOL cycle (0-120 seconds) – Time fan is delayed turning ON at start of cool cycle. For no delay, set to 0:00. Press the \vee or \wedge button to set delay. **CAUTION!** Changing from the default of 0:00 may permanently damage your system. Press the \gt button to advance to the next screen.

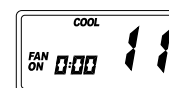
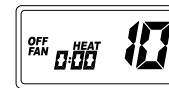
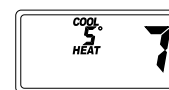
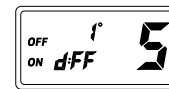
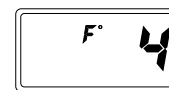

12. Fan OFF Delay – COOL cycle (0-240 seconds) – Time fan is delayed turning OFF after cool cycle. For no delay, set to 0:00. Press the \vee or \wedge button to set delay. **CAUTION!** Changing from the default of 0:00 may permanently damage your system. Press the \gt button to advance to the next screen.

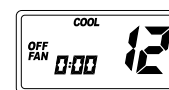

13. Maximum run cycles allowed per hour (d, 2-6). d = as many as needed, 2-6 = maximum cycles/hour. Press the \vee or \wedge button to select. Press the \gt button to advance to the next screen.

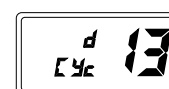

14. Auxiliary Delay ON – (0-30 minutes) – For heat pump systems only. Set the delay time in minutes for auxiliary heat to be locked out after a call for second stage. Press the \vee or \wedge button to select. Press the \gt button to advance to the next screen.

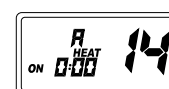

15. Status indicator (0, 1, 2) – Choose when status indicator LED (green, red) illuminates.
 - 0 = Status indicator never on
 - 1 = Status indicator on with first stage
 - 2 = Status indicator on with second stage
 Press the \vee or \wedge button to select. Press the \gt button to advance to the next screen.

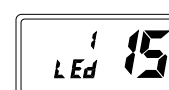

16. Lockout (0°F to 8°F, NITE, COOL-HEAT) – Select the number of degrees set temperature can be changed during keypad lockout or select to lockout during NITE period only. COOL-HEAT lockout allows adjustment of the set temperatures to the maximum heat set temperature selected in Step 17 and minimum cool set temperature selected in Step 18. ***Note:** The mode cannot be changed when the thermostat is locked. Press the \vee or \wedge button to select. Press the \gt button to advance to the next screen.



17. Maximum Heat Setpoint (45°F to 90°F) (7°C to 32°C) Adjust to control the maximum Heat set temperature allowed. Press the \vee or \wedge button to select. Press the \gt button to advance to the next screen.

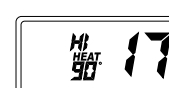

18. Minimum Cool Setpoint (45°F to 90°F) (7°C to 32°C) Adjust to control the minimum Cool set temperature allowed. Press the \vee or \wedge button to select. Press the \gt button to advance to the next screen.

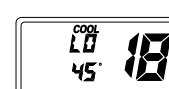

19. Room Temperature Offset (+9°F to -9°F) (+5°C to -5°C) Adjust to calibrate displayed room temperature to match actual room temperature. Press the \vee or \wedge button to select. To exit Configuration Mode, hold in the \gt button for 6 seconds.



Testing the Thermostat

Once the thermostat is installed, it should be thoroughly tested.

CAUTION! Do not energize the air conditioning system when the outdoor temperature is below 50 degrees. It can result in equipment damage or personal injury.

Cool Test

1. Press mode \lt button until cool mode screen is displayed.
2. Adjust set temperature so it is 5 degrees below room temperature.
3. Air conditioning should come on within a few seconds.
4. Adjust the set temperature 2 degrees above the room temperature and the A/C should turn off. There may be a fan delay on your system. ***Note:** There is a four minute time delay to protect the compressor after it turns off. To temporarily bypass the four minute delay, press the \lt button four times.

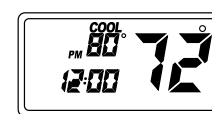

Heat Test

1. Press mode \lt button until heat mode screen is displayed.
2. Adjust the set temperature so it is 5 degrees above the room temperature.
3. Heat should come on within a few seconds.
4. Adjust the set temperature so it is 2 degrees below the room temperature and the heat should turn off. There may be a fan delay on your system.

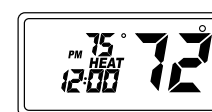

Mode of Operation

The Daikin Programmable Thermostat is an auto changeover, two stage heat, two stage cool thermostat.

The thermostat activates a heating appliance when the room temperature is below the set heat temperature (by the differential temperature). The red status indicator may come on with first or second stage, depending on configuration. When it drops another two degrees, the second stage (auxiliary) heat is activated. The heating is staged off when the room temperature increases.

When the room temperature is greater than the set cool temperature (by the differential temperature), the first stage cooling device is activated. The green status indicator may come on with first or second stage, depending on configuration. If the room temperature increases two more degrees, the second stage cooling device will be activated. The cooling is staged off when the room temperature decreases.

The thermostat has the following operating modes: OFF, Heat, Cool, Cool and Heat, and Program mode. In OFF mode, the thermostat will not turn on heating or cooling devices. The indoor fan can be turned on in all operating modes using the fan switch. In the Heat mode, the thermostat controls the heating system. In the Cool mode, the thermostat controls the cooling system. In the Cool and Heat mode, the thermostat controls both the cooling and heating systems. In Program mode, the thermostat will automatically be controlled by the set program. Program mode can function with Heat mode, Cool mode, Cool and Heat mode or OFF mode (for Programmable fan option only). The clock display alternates with the set temperature display for Cool and Heat mode.

The program schedule can be overridden by changing the set temperature (∨ or ∧). This puts the thermostat into a 2-hour temporary hold. After 2 hours, it will automatically return to the program schedule.

The thermostat also has a button lockout feature. This enables the thermostat to be set to the proper mode and temperature and locked so it cannot be tampered with.

Operating Modes

Program Overview: These are the possible operating modes for the Daikin programmable thermostat.

OFF Mode

In this mode, the thermostat will not turn on the heating or cooling devices.

✱ **Note 1:** *The indoor fan can be turned on manually in every operating mode by sliding the Auto/On switch to ON.*



✱ **Note 2:** *To enter Programming Fan Only Mode, press the > button once. Only the indoor fan will operate during that period if it is activated in the program setup.*

Cool Mode



Heat Mode

In this mode, the thermostat controls the heating system.



Cool and Heat Mode

The thermostat controls the heating and cooling systems, automatically changing over from one to the other as required.

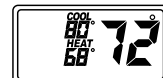

Program Mode

In this mode, the program function is on, and the thermostat will automatically be controlled by the set program. Program mode can function with Heat mode, Cool mode, Cool and Heat mode or OFF mode (for Programmable fan option only).

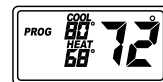

Press the > button to enter and exit program mode.

Program Mode Hold

The program schedule can be overridden by changing the set temperature (∨ or ∧). After 2 hours, the program schedule will automatically be resumed. To return to the program schedule manually, press the > button twice.

Setting the Time and Day of the Week

The time and day of the week must be set for your program schedule to operate correctly.

- Verify thermostat is in non-programmable mode (use the > button to exit prog mode).
- Press and release < button until OFF mode displays.



Note: *Press the > button in for 5 seconds to lock values into memory or press the > button once to enter programming.*

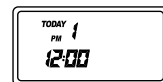

Programming

Program Overview

The Daikin Programmable Thermostat has four periods (MORN, DAY, EVE, NITE) that are customizable for each day of the week. Each period will have a start time, heat temperature, cool temperature and programmable fan. The thermostat monitors the day and time, while maintaining the specific conditions you have chosen for each period in your program.

- Verify thermostat is in non-programmable mode (use the > button to exit prog mode).
- Press and release the < button until OFF mode displays.
- Press the > button for 6 seconds.
- Press the > button twice.

- Day is displayed (1-7)
- Press the ∨ or ∧ button to change the day you want to program (1=Monday, 2=Tuesday, etc).
 - Press the > button to advance to the next screen.
- ✱ **Note:** *You can always press the < button to return to the previous screen.*

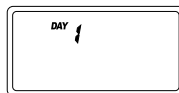

- Period is displayed (MORN, DAY, EVE, NITE)
- Press the ∨ or ∧ button to change period of day.
 - Press the > button to advance to the next screen.



- Set time is displayed
- Press the ∨ or ∧ button to change set time.
 - Press the > button to advance to the next screen.
- ✱ **Note:** *Transitions required after 11:59 PM must be programmed in the next day's MORN period.*



- Heat temperature is displayed (50°F to 90°F)
- Press the ∨ or ∧ button to adjust heat set temperature.
 - Press the > button to advance to the next screen.

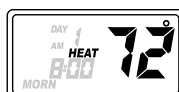

- Cool temperature is displayed (45°F to 85°F)
- Press the ∨ or ∧ button to adjust cool set temperature.
 - Press the > button to advance to the next screen.



- Programmable fan is displayed
- Press the ∨ or ∧ button to turn ON/OFF continuous indoor fan for that period.
 - Press the > button to advance to the next screen.



Repeat steps 1-16 to program each day of the week individually or use the Simpleset® feature to program every day the same as Monday.

Press the > button for 5 seconds to exit programming and return to the OFF mode.

Press the < button to select the correct operating mode.

Press the > button to enter and exit program mode.

Simpleset® Programming

Simpleset® programming is a convenient method of programming the thermostat. Once the entire Monday (Day 1) schedule is set, Simpleset® programming will copy the Monday schedule to every day of the week.

After the complete Monday schedule is set (see Programming), you are at the Day 2 screen:

- Press the ∨ button once. Day 1 screen displays.
- Press the ∨ button for 2 seconds.
 - The days of the week will count down from 7 to 1 and this will lock the settings into memory.
 - Once the schedule is locked in, you can go through each day and make any changes you require. This feature speeds up the programming of the standard weekday/weekend schedule.
- Press > button for 5 seconds to exit Program mode.

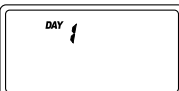

Lockout Feature

The Daikin Programmable Thermostat has a button lockout feature so the mode cannot be changed and the temperature adjustment is limited. Select the appropriate lockout from Configuration Mode Settings, Step 16, of this guide.

To activate the LOC feature:

- Press the < button and hold it in.
- Also press > button and keep both depressed for 10 seconds.
- LOC will display and the Lockout Function will be enabled.

To deactivate the LOC feature, repeat steps 1 & 2 above (in this section).



Factory Preprogramming

The Daikin Programmable Thermostat comes preprogrammed with the following schedule:

MONDAY thru SUNDAY	MORN	6:00 AM	DAY	8:00 AM	EVE	6:00 PM	NITE	10:00 PM
	HEAT	70°F	HEAT	62°F	HEAT	70°F	HEAT	62°F
	COOL	78°F	COOL	85°F	COOL	78°F	COOL	82°F
	FAN*	ON/OFF	FAN*	ON/OFF	FAN*	ON/OFF	FAN*	ON/OFF

* Programmable fan option

Personal Program Schedule

Use the following personal program schedule to record your settings:

MONDAY 1	MORN	DAY	EVE	NITE
	HEAT	HEAT	HEAT	HEAT
	COOL	COOL	COOL	COOL
	FAN*	ON/OFF	FAN*	ON/OFF

* Programmable fan option

TUESDAY 2	MORN	DAY	EVE	NITE
	HEAT	HEAT	HEAT	HEAT
	COOL	COOL	COOL	COOL
	FAN*	ON/OFF	FAN*	ON/OFF

WEDNESDAY 3	MORN	DAY	EVE	NITE
	HEAT	HEAT	HEAT	HEAT
	COOL	COOL	COOL	COOL
	FAN*	ON/OFF	FAN*	ON/OFF

THURSDAY 4	MORN	DAY	EVE	NITE
	HEAT	HEAT	HEAT	HEAT
	COOL	COOL	COOL	COOL
	FAN*	ON/OFF	FAN*	ON/OFF

5	MORN	DAY	EVE	NITE
	HEAT	HEAT	HEAT	HEAT
	COOL	COOL	COOL	COOL
	FAN*	ON/OFF	FAN*	ON/OFF

6	MORN	DAY	EVE	NITE
	HEAT	HEAT	HEAT	HEAT
	COOL	COOL	COOL	COOL
	FAN*	ON/OFF	FAN*	ON/OFF

SUNDAY 7	MORN	DAY	EVE	NITE
	HEAT	HEAT	HEAT	HEAT
	COOL	COOL	COOL	COOL
	FAN*	ON/OFF	FAN*	ON/OFF

Daikin 7-Day Programmable Thermostat

Factory Defaults

✱ NOTE: <i>Following are the factory default settings for the Daikin thermostat:</i>		
1.	Heat Pump	OFF
2.	Reversing Valve O/B	N/A
3.	Heat Electric	ON
4.	F/C	F
5.	Differential Stage 1	1
6.	Differential Stage 2	2
7.	Deadband	5
8.	Staged Off Outputs	ON
9.	Heat Fan Delay on	0:00
10.	Heat Fan Delay off	0:00
11.	Cool Fan Delay on	0:00
12.	Cool Fan Delay off	0:00
13.	Cycles Per Hour	d
14.	Auxiliary Delay on	N/A
15.	LED indicator	1
16.	Key Pad Lockout	0
17.	Maximum Heat Setpoint	90
18.	Minimum Cool Setpoint	45
19.	Calibration	0

Troubleshooting

Symptom	Remedy
No display	Check for 24 VAC/VDC at thermostat; display is blank when 24 VAC/VDC is not present
System fan does not come on properly	Verify wiring is correct, check electric heat setup in configuration (see "Configuration Mode")
Program schedule activates at the wrong time	Check time (AM/PM) set on thermostat (see "Setting the Time")
Thermostat turns on and off too frequently	Adjust temperature differential (see "Differential," Configuration Mode Setting 5)
Thermostat does not follow program	Verify it is operating in Program mode (PROG displays); check time (AM/PM)
Fan runs continuously	Check fan On/Auto switch; check programmable fan setting in program; check fan settings in configuration (see "Configuration Mode")
Room temperature is not correct	Verify wall hole is plugged with putty or insulation; check wiring and location for remote sensor if used
LOC displays when any button is pressed or thermostat buttons are inoperative	Thermostat has the button lockout function activated (see "Lockout Feature")
Very limited setpoint adjustment	Thermostat has the button lockout function activated (see "Lockout Feature") Check configuration mode settings
Problem not listed above	Press Reset button once*

* **Reset Button Function:** *Time, day and mode changed to last saved settings (saved after power loss or when exiting program setup), configuration and program settings are unchanged.*

Daikin Training and Development

Now that you have made an investment in modern, efficient Daikin equipment, its care should be a high priority. For training information on all Daikin HVAC products, please visit us at www.DaikinApplied.com and click on Training, or call 540-248-9646 and ask for the Training Department.

Warranty

All Daikin equipment is sold pursuant to its standard terms and conditions of sale, including Limited Product Warranty. Consult your local Daikin Representative for warranty details. Refer to Form 933-430285Y. To find your local Daikin Representative, go to www.DaikinApplied.com.

Aftermarket Services

To find your local parts office, visit www.DaikinApplied.com or call **800-37PARTS (800-377-2787)**. To find your local service office, visit www.DaikinApplied.com or call **800-432-1342**. This document contains the most current product information as of this printing. For the most up-to-date product information, please go to www.DaikinApplied.com.

Products manufactured in an ISO certified facility.



www.DaikinApplied.com