



# Installation and Operation

## Trane™ Touch-screen Programmable Thermostat



**Trane Part Number:** X13511538-01  
**Clarksville Part Number:** BAYSTAT152A  
**Service Part Number:** THT02775

### SAFETY WARNING

Only qualified personnel should install and service the equipment. The installation, starting up, and servicing of heating, ventilating, and air-conditioning equipment can be hazardous and requires specific knowledge and training. Improperly installed, adjusted or altered equipment by an unqualified person could result in death or serious injury. When working on the equipment, observe all precautions in the literature and on the tags, stickers, and labels that are attached to the equipment.

## Copyright

© 2011 Trane. All rights reserved.

This document and the information in it are the property of Trane and may not be used or reproduced in whole or in part, without the written permission of Trane. Trane reserves the right to revise this publication at any time and to make changes to its content without obligation to notify any person of such revision or change.

## Trademarks

Trane and its logo are trademarks of Trane in the United States and other countries. All trademarks referenced in this document are the trademarks of their respective owners.

## Warnings, Cautions, and Notices

Warnings, cautions, and notices are provided in appropriate places throughout this document:

**⚠ WARNING:** Indicates a potentially hazardous situation which, if not avoided, could result in death or serious injury.

**⚠ CAUTION:** Indicates a potentially hazardous situation which, if not avoided, could result in minor or moderate injury. It could also be used to alert against unsafe practices.

**NOTICE:** Indicates a situation that could result in equipment or property-damage-only accidents.



# Table of Contents

Overview .....	5
Packaged Contents and Tools .....	5
Packaged Contents .....	5
Tools .....	5
Specifications and Dimensions .....	6
Product Features and Functions .....	7
Features .....	7
Functions .....	7
Pre-Installation .....	8
Location Considerations .....	8
Height Requirements .....	8
Mounting Surfaces .....	8
Maximum Wire Length .....	9
Installation and Wiring .....	10
Mounting the Thermostat and Cover Removal .....	10
Mounting the Backplate .....	10
Wiring and Wiring Diagrams .....	12
Wiring .....	12
Terminal Identification .....	13
Wiring Diagrams .....	13
Thermostat Cover Replacement .....	18
Power, System Tests, and Software Reset .....	19
Applying Power .....	19
Power-up Test .....	19
System Tests .....	20
Software Reset .....	22
Configuration Option Setup .....	23
Installation Options .....	24
Operation .....	27
Thermostat Icon Descriptions .....	27
Functions .....	28
Time Setup .....	28
Dehumidify Setup .....	28
System Mode Setup .....	29
Fan Mode .....	29

Temporary Override (TOV) Setup .....	30
General Notes: .....	30
Schedule Setup .....	31
Schedule Display Mode .....	31
Day/Period/Time Schedule Change Mode .....	32
Setpoint/Fan Schedule Change Mode .....	33
General Notes for All Schedule Modes .....	34
Other Thermostat Functions .....	36
Heat/Cool Indicator Display .....	36
Non-programmable Mode .....	37
Filter Change .....	38
Clean Screen .....	38
Local/Remote/Outdoor Temperature Display and Control .....	39
Local/Remote Humidity Display and Control .....	40
System Lockout .....	41
To lock the thermostat: .....	41
To unlock the thermostat: .....	41
Temperature Cycle Control .....	42
Other Functional Components .....	44
Sleep Mode .....	44
Changeover Operation .....	44
Changeover Valve Control .....	44
Extension of Fan-on Time .....	45
Economizer/Time of Day (TOD) .....	45
Configuration, Time, and Programming Retention .....	45
Heat/Cool Relay Confirmation .....	45
Deadband .....	45
Temperature Display Offset .....	46
Humidity Display Offset .....	46
LCD Backlight .....	46
Compressor Protection .....	46
Permanent Memory Data .....	46
Compressor and Auxiliary Heat Lockout .....	47
Error Codes and Exceptions .....	48
Error Codes .....	48
Exceptions .....	49
Troubleshooting .....	50



## Overview

The Trane™ Touch-screen Programmable Thermostat is for use with conventional Rooftop Units (RTU) air conditioners and heat pumps. These units are compact, easy to install, configure, and operate.

This installation and operation manual provides information about the following:

- Specifications and dimensions
- Product features and functions
- Pre-installation requirements
- Installation and wiring
- Power, system tests, and software reset
- Configuration option setup
- Other thermostat functions
- Temperature cycle control
- Other functional components
- Error codes and exceptions
- Troubleshooting

**Note:** *Before beginning installation, visually inspect all parts for obvious defects for damage. All components are thoroughly inspected before leaving the factory. Any claims for damage incurred in shipping should be filed immediately with the carrier.*

## Packaged Contents and Tools

### Packaged Contents

Each programmable thermostat ships with the following:

- One (1) Trane Touch-screen Programmable Thermostat
- One (1) Installation/Configuration Instructions (X39641190-01)
- One (1) Setup/Programming Instructions (X39641189-01)
- One (1) bag of:
  - Two (2) machine screws
  - Two (2) wood screws
  - One (1) security screw
  - Two (2) wall anchors
  - Two (2) terminal blocks; an 8-pin and a 6-pin

### Tools

- One (1) 1/8 inch, flat-bladed service screwdriver
- One (1) small Phillips screwdriver
- Level
- Drill
- Hammer
- Wire cutter/stripper

# Specifications and Dimensions

The following table and illustration provides the thermostat specifications and dimensions.

**Table 1. Specifications and dimensions**

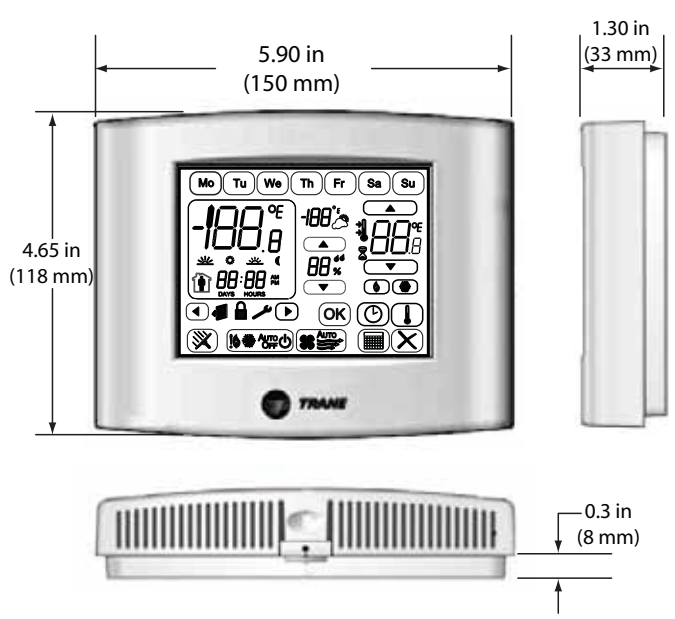
<b>Storage</b>	
Temperature:	-4°F to 158°F (-20°C to 70°C)
Relative Humidity:	Between 5% and 95% (noncondensing)
<b>Operating</b>	
Temperature:	32°F to 122°F (0°C to 50°C)
Humidity:	Between 5% and 95% (noncondensing)
Input Power:	24 Vac (minimum 18 Vac/maximum 32 Vac), 50Hz to 60Hz <b>Note:</b> Frequency is selected using Configuration Option #0190.
Power Consumption:	<2 Watts @24 Vac RMS nominal
Wire Size:	18 to 22 AWG
Output Terminal Rating:	1A @ 30 Vac
Temperature Accuracy:	±1.4°F (0.8°C) from 50°F to 90°F (10°C to 32.2°C)
Temperature Resolution:	Configurable @1°F, 0.5°F, 1°C, 0.5C, 0.1°C
Humidity Accuracy:	±3% RH from 20% to 80% RH
Humidity Resolution:	1%
Housing Material:	<ul style="list-style-type: none"> <li>Polycarbonate/ABS Blend</li> <li>UV protected</li> <li>U.L. 94-5VA flammability rating</li> </ul>
Mounting:	3.24 in (8.26 cm) for two mounting screws ( <i>supplied</i> )
<b>Dimensions</b>	
 <p>The diagram shows three views of the thermostat: a front view, a side view, and a bottom view. The front view shows a width of 5.90 in (150 mm) and a height of 4.65 in (118 mm). The side view shows a depth of 1.30 in (33 mm). The bottom view shows a mounting hole offset of 0.3 in (8 mm) from the bottom edge.</p>	



# Product Features and Functions

The following is a list of features and functions of the programmable thermostat.

## Features

Liquid Crystal Display (LCD) Touch Screen: with symbols for temperature, setpoints, and system operating modes. In addition, the thermostat has settings for the day of the week, time of day, and occupancy.

- System Modes:
  - Heat
  - Cool
  - Auto
  - Off
  - Emergency heat
- Fan Modes:
  - On
  - Auto
- System Configurations:
  - 1 heat/1 cool conventional
  - 1 heat/1 cool heat pump
  - 1 heat conventional (with and without fan)
  - 1 cool conventional
  - 2 heat/1 cool heat pump
  - 2 heat/2 cool conventional
  - 2 heat/1 cool conventional
  - 1 heat/2 cool conventional
  - 2 heat/2 cool heat pump
  - 3 heat/2 cool heat pump
- Time and Dehumidify Settings
- Temporary Override (TOV)
- Scheduling:
  - All days: (Mo, Tu, We, Th, Fr, Sa, Su)
  - Five (5) days, plus one day, plus one day: (Mo, Tu, We, Th, Fr), (Sa),(Su)
  - Five (5) days, plus two days,: (Mo, Tu, We, Th, Fr,) (Sa, Su)
  - Seven (7) individual days [**default**]: (Mo) (Tu) (We) (Th) (Fr) (Sa) (Su)
- Temperature Cycling Control (Patent Pending):
  - Integrated adjustable deadband staging
  - Configurable cycles per hour (CPH) heat/cool cycles

## Functions

The touch-screen programmable thermostat provides additional functions that provide more flexibility and control. Refer to the sections, "[Other Thermostat Functions](#)," p. 36 and "[Other Functional Components](#)," p. 44.

## Pre-Installation

This section provides the following pre-installation information:

- Location considerations
- Height requirements
- Mounting surfaces
- Maximum wire length

### Location Considerations

When selecting a location, avoid the following areas when installing the thermostat:

- Direct sunlight
- Direct airstream of air diffusers
- Exterior walls and other walls that have a temperature differential between the two sides
- Close proximity to heat sources such as sunlight, appliances, concealed pipes, chimneys, or other heat-generating equipment
- Drafty regions
- Dead spots behind doors, projection screens, or corners
- Walls subject to high vibration
- High humidity regions
- High traffic areas (to reduce accidental damage or tampering)

### Height Requirements

It is recommended to mount the thermostat a maximum distance of 54 inches (137 cm) above the floor. If a parallel approach by a person in a wheelchair is required, reduce the maximum height to 48 inches.

**Note:** For further details regarding wheelchair requirements, refer to *ADA Standards for Accessible Design/4.27 Controls and Operating Mechanisms/4.27.3 Height* online at [www.ADA.gov](http://www.ADA.gov) and to local building codes.

### Mounting Surfaces

The thermostat can be mounted to any sturdy, vertical surface. Plastic-threaded anchors and M3.5 x 20 mm screws are provided for mounting to plaster or wallboard; 6-32 x 3/4 inch machine screws are provided for mounting directly to a standard electrical device box. For other surface types, the user must provide fasteners that are appropriate for the surface.



## Maximum Wire Length

The thermostat may not function properly if the total resistance of any of the thermostat wires exceeds 2.5 ohms (refer to [Table 2](#)).

**Important:** Ensure that the wires from the thermostat to the HVAC equipment do not exceed lengths shown in [Table 2](#). **Best practice:** use shorter wire lengths.

**Table 2. Maximum wire lengths**

Copper Wire size	Maximum Recommended Wire Length From Thermostat to HVAC Equipment	Remote Temperature Sensor to Thermostat (Max <sup>(a)</sup> )	Remote Humidity Sensor to Thermostat (Max <sup>(a)</sup> )
18 AWG (0.75 mm <sup>2</sup> )	385 ft (117 m)	2,500 ft (762 m)	385 ft (117 m)
20 AWG (0.50 mm <sup>2</sup> )	240 ft (73 m)	1,500 ft (457 m)	240 ft (73 m)
22 AWG (0.33 mm <sup>2</sup> )	150 ft (46 m)	1,000 ft (305 m)	150 ft (46 m)

(a) Temperature and humidity readings can be adjusted in the configuration setup for longer wire runs.



## Installation and Wiring

This section provides information about the following:

- Mounting the thermostat and cover removal
- Wiring and wiring diagrams
- Thermostat cover replacement

### Mounting the Thermostat and Cover Removal

Before beginning installation, it is recommended to re-read the section, “[Pre-Installation](#),” p. 8 and then ensure that the following conditions are met:

- A wire access hole is available at the thermostat location
- The wires are accessible through the hole
- The wires are attached to the appropriate terminals on the HVAC equipment
- There is continuity (*and not more than 2.5 ohms resistance*) between the thermostat location and the HVAC equipment
- The wires are accurately labeled or color coded

### Mounting the Backplate

#### **WARNING**

#### **Hazardous voltage!**

**Disconnect all electric power, including remote disconnects before servicing. Follow proper lockout/tagout procedures to ensure the power cannot be inadvertently energized. Failure to disconnect power before servicing could result in death or serious injury.**

#### **NOTICE**

#### **Equipment damage!**

**Applying excessive voltage to the thermostat can permanently damage it.**

To mount the backplate:

1. Shut off the power to all HVAC equipment. If the security screw was previously installed, remove it (refer to [Figure 1, p. 11](#)).

**Figure 1. Security screw removal and cover release**

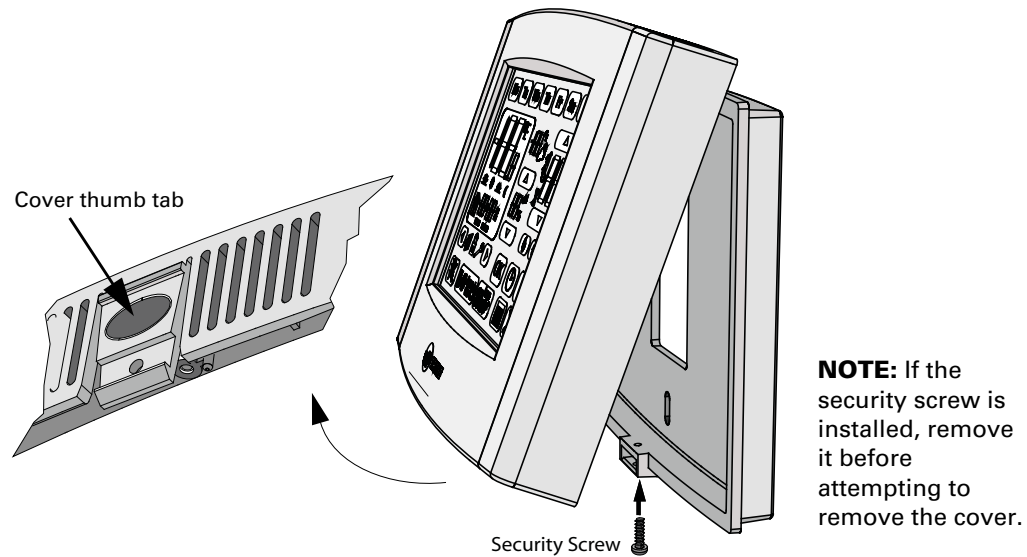

2. Push the cover thumb tab to release the cover from the backplate as shown above.
3. Route the wires through the opening in the backplate as shown below. Wires should be marked to ensure proper connection to terminals.

**Figure 2. Wire routing, mounting, and mounting dimensions**

Dimension	Programmable Touch-screen
H	3.3 in. (85 mm)
W	5.9 in. (150 mm)
D	1.3 in. (33 mm)
M	3.3 in. (85 mm)

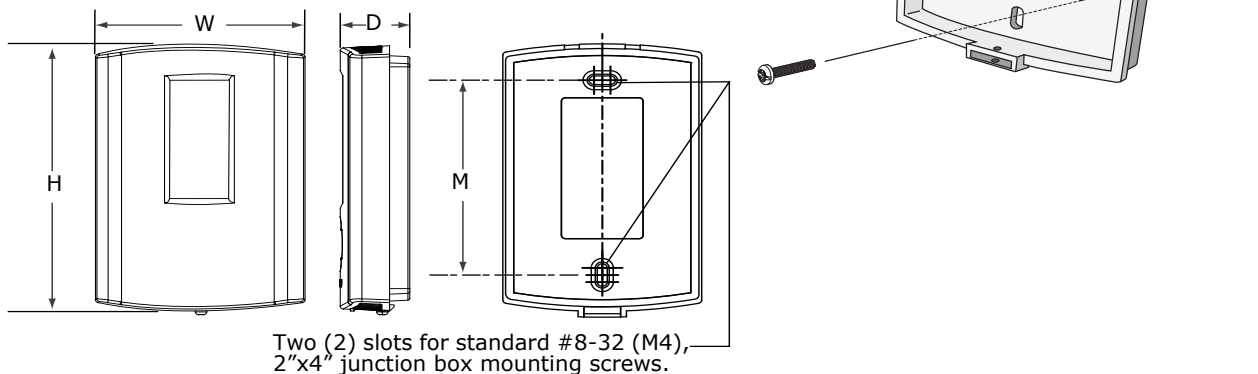

4. If mounting the backplate directly to a wall surface, hold the backplate against the surface and then level and mark the fastener locations.
5. Secure the backplate using appropriate fasteners (refer to the section, "[Mounting Surfaces](#)," p. 8.) The thermostat must be level and plumb to ensure proper air movement through the thermostat enclosure.

## Wiring and Wiring Diagrams

### Wiring

#### **WARNING**

##### **Hazardous voltage!**

Disconnect all electric power, including remote disconnects before servicing. Follow proper lockout/tagout procedures to ensure the power cannot be inadvertently energized. Failure to disconnect power before servicing could result in death or serious injury.

#### **NOTICE**

##### **Equipment damage!**

Applying excessive voltage to the thermostat can permanently damage it.

**Note:** Terminal blocks are included with the mounting hardware contained in a small plastic bag (new installation) or remove terminal blocks from pin header (existing installation).

To wire the thermostat:

1. Connect the wires to the terminal block(s) by:
  - a. Removing approximately 1/4 inch (6 mm) of insulation from the wires.
  - b. Using the terminal block screws to securely fasten each wire into the terminal block.

**Note:** Refer to [Table 3, p. 13](#) and the wiring diagrams on page 14- through 18 to determine the correct terminal for each wire.

*In some cases the terminal labels (such as Y, G, or R) correctly correspond to the first letter of the color wire in which they are connected. However, it is important to verify which equipment terminals are connected at the other ends of the wires before connecting the wires to the thermostat.*

2. Align the pins/label on the circuit board with the holes/label on the terminal blocks and gently push the wired terminal blocks into place on the circuit board (refer to [Figure 3](#)).

**Figure 3. Attaching the wired terminal blocks to the pins on the circuit boards**

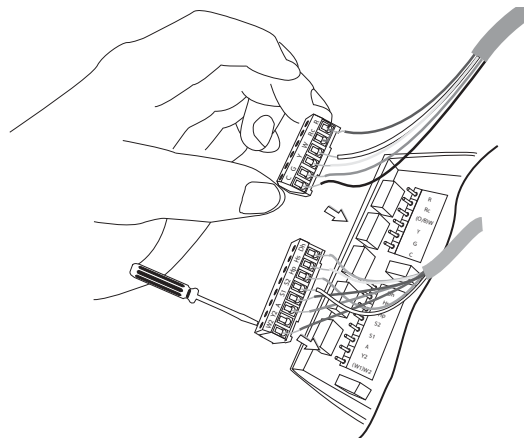

3. Push the excess wire through the hole in the wall cavity or into the junction box.

**Important:** Do not coil excess wire between the thermostat and the backplate. Use non-flammable insulation to prevent air movement between the wall cavity and the thermostat.

### Terminal Identification

Table 3 identifies the programmable thermostat terminals.

**Table 3. Terminal identification**

Connector Type	Terminal Label <sup>(a)</sup>	Terminal Description
8-pin Connectors	Dh	Dehumidify relay
	Hs	External humidity sensor input
	Hp	External humidity sensor power
	S2	External temperature sensor
	S1	External temperature sensor
	A	Economizer relay
	Y2	Stage 2 compressor control relay
	(W1)W2	(Aux or Em heat relay) <sup>(b)</sup> Second stage heat relay
6-pin connectors	R	24 Vac heating <b>Important:</b> Terminal shipped with jumper connected. Remove jumper if the 24 Vac power supplies are separate.
	Rc	24 Vac cooling <b>Important:</b> Terminal shipped with jumper connected. Remove jumper if the 24 Vac power supplies are separate.
	(O/B)W	(Changeover valve) <sup>(b)</sup> Heat relay
	Y	Stage 1 compressor control relay
	G	Fan relay
	C	Common

(a) Label order above is how they appear on the thermostat terminal block.  
 (b) Text in parentheses applies to only heat pump systems.

### Wiring Diagrams

The following diagrams show typical wiring scenarios for the touch-screen programmable thermostat.

Use Table 4 and the corresponding figure to correctly wire the thermostat.

**Table 4. System type options for programmable thermostats**

System Type	Value for Option 130	See Diagram
1-heat/1-cool, conventional	1	<a href="#">Figure 4</a>
1-heat/1-cool, heat pump without auxiliary heat	2	<a href="#">Figure 5</a>
1-heat only, conventional without fan	3	<a href="#">Figure 6</a>
1-heat only, conventional with fan	4	<a href="#">Figure 7</a>
1-cool, conventional	5	<a href="#">Figure 8</a>
2-heat/1-cool, heat pump with auxiliary heat	6	<a href="#">Figure 9</a>
2-heat/2-cool, conventional	7	<a href="#">Figure 10</a>
2-heat/1-cool, conventional	8	<a href="#">Figure 11</a>
1-heat/2-cool, conventional	9	<a href="#">Figure 12</a>
2-heat/2-cool, heat pump without auxiliary heat	10	<a href="#">Figure 13</a>
3-heat/2-cool, heat pump with auxiliary heat	11	<a href="#">Figure 14</a>

**Figure 4. Programmable Thermostat, 1H/1C, Conventional (Option 1)**

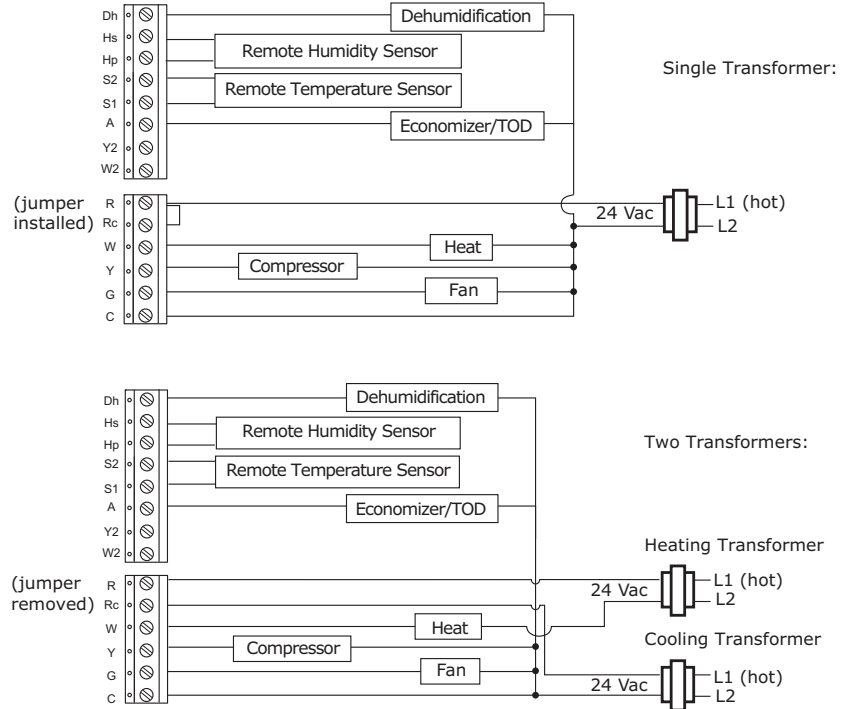

**Figure 5. Programmable Thermostat, 1H/1C, Heat Pump Without Auxiliary Heat (Option 2)**

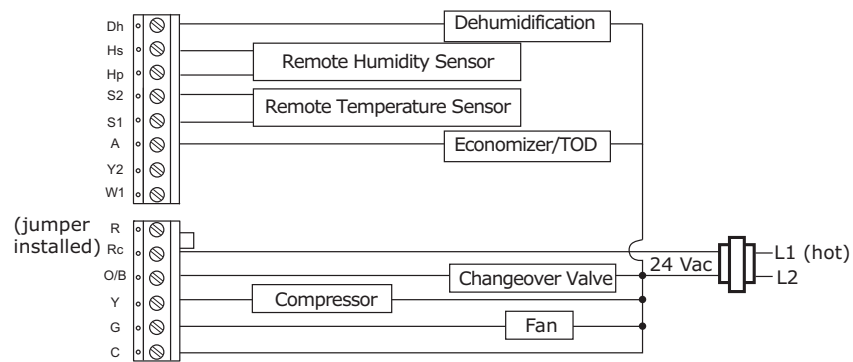

**Figure 6. Programmable Thermostat, 1H Only, Conventional Without Fan (Option 3)**

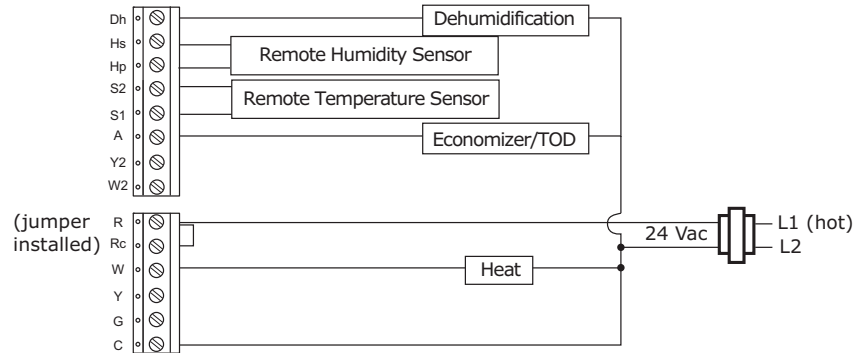

**Figure 7. Programmable Thermostat, 1H, Conventional With Fan (Option 4)**

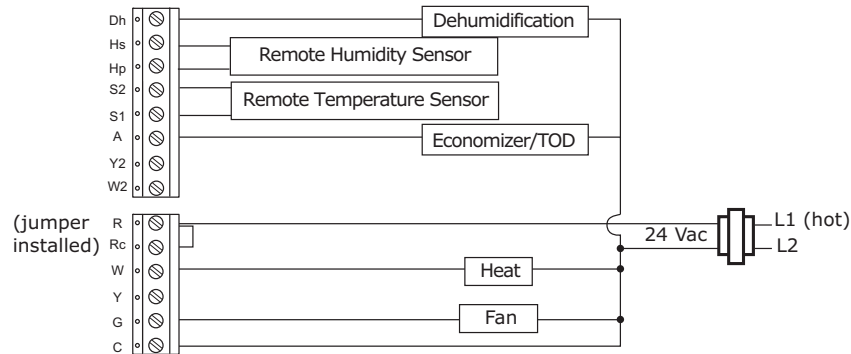

**Figure 8. Programmable Thermostat, 1C, Conventional (Option 5)**

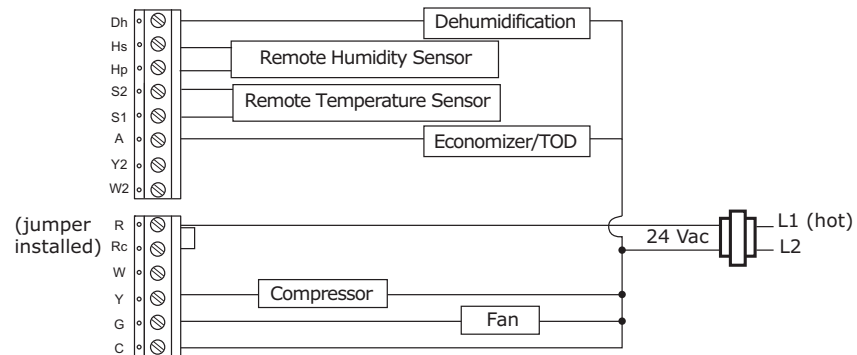

**Figure 9. Programmable Thermostat, 2H/1C, Heat Pump With Auxiliary Heat (Option 6)**

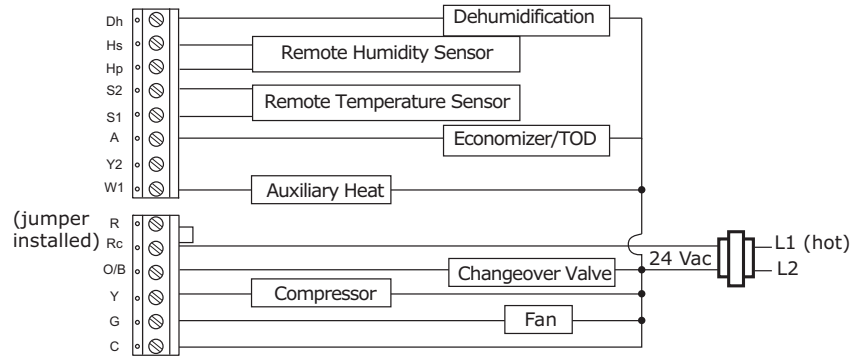

**Figure 10. Programmable Thermostat, 2H/2C, Conventional (Option 7)**

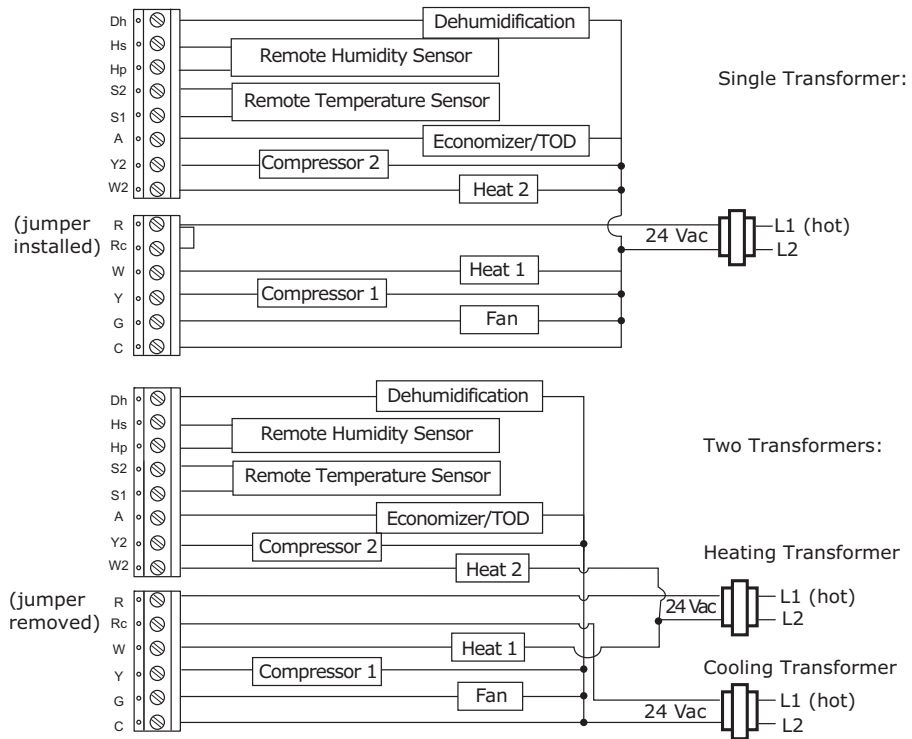



Figure 11. Programmable Thermostat, 2H/1C, Conventional (Option 8)

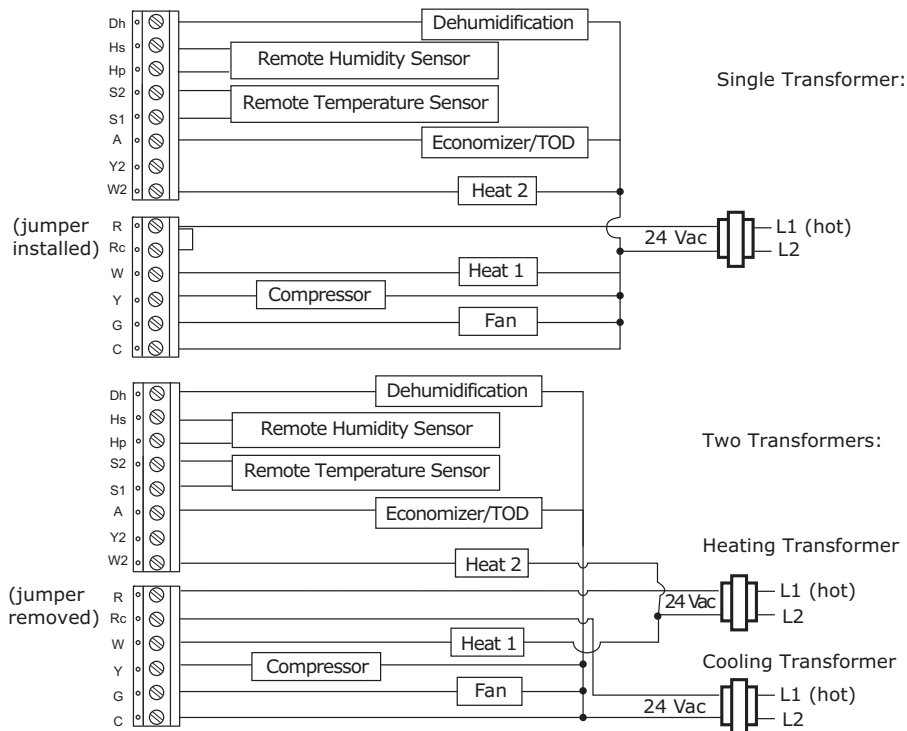
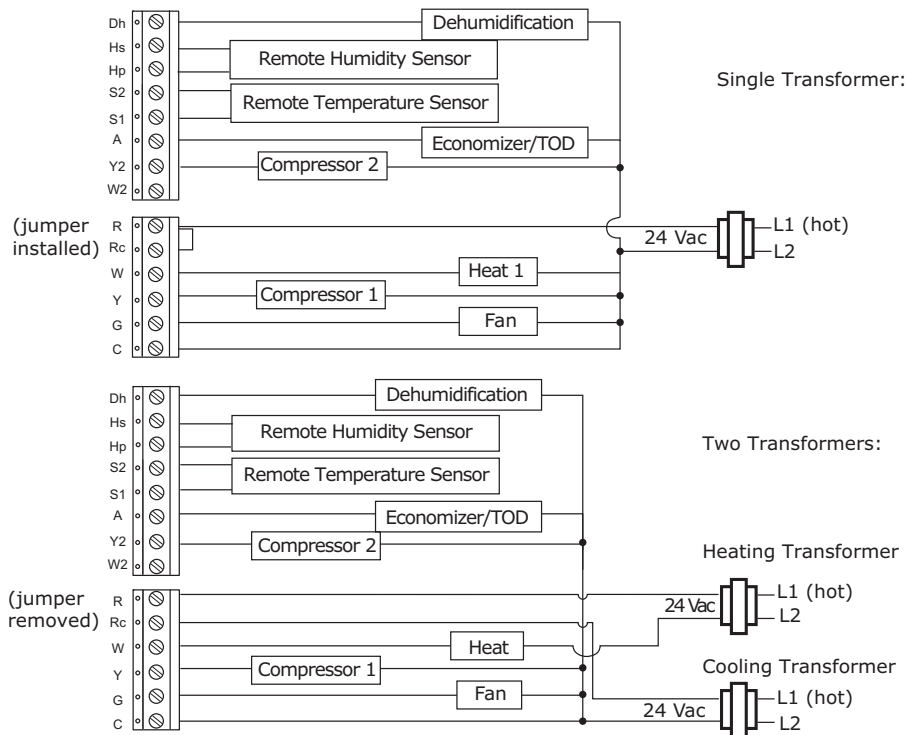
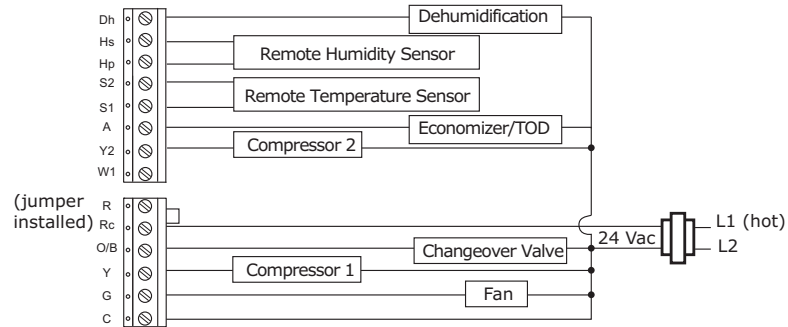

Figure 12. Programmable Thermostat, 1H/2C, Conventional (Option 9)



**Figure 13. Programmable Thermostat, 2H/2C, Heat Pump Without Auxiliary Heat (Option 10)**



**Figure 14. Programmable Thermostat, 3H/2C, Heat Pump With Auxiliary Heat (Option 11)**

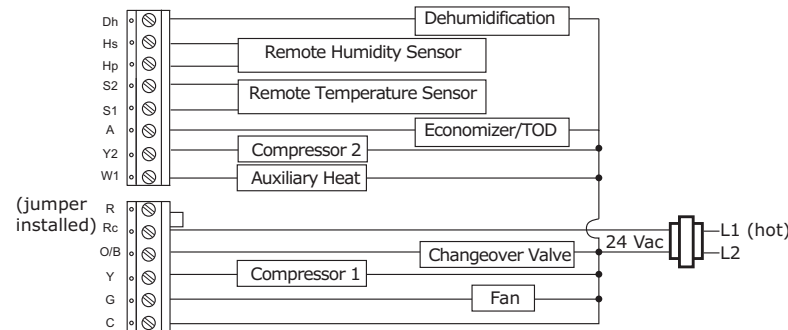

## Thermostat Cover Replacement

After completing all wiring, replace the thermostat cover. To replace the cover:

1. Hook the cover over the top of the backplate. Apply light pressure to the bottom of the cover until it snaps into place.
2. To help deter tampering, install the security screw into the bottom of the cover as shown below.

**Figure 15. Close cover and replace security screw**

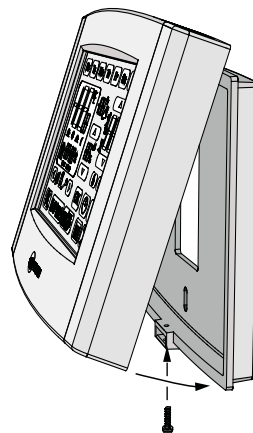

Install security screw to deter tampering.

## Power, System Tests, and Software Reset

This section provides information about:

- Applying power
- Power-up test
- System tests

### Applying Power

Restore power to the HVAC equipment. The thermostat initiates a power-up test and will display an error, if one is detected (refer to the sections, “Power-up Test,” p. 19 and “Error Codes,” p. 48). If no errors are detected, the home screen appears as shown in Figure 16.

Figure 16. Home screens

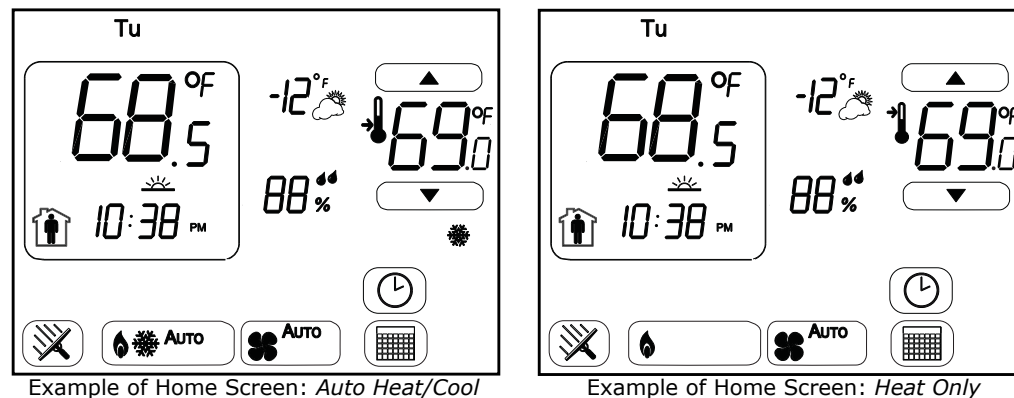

### Power-up Test

The power-up test is performed any time power is applied to the thermostat. At the start of the power-up test, the thermostat screen will display the following sequence of events, *in order*:

- All icons for approximately 1.5 seconds and then;
- The firmware version for 1.5 seconds (*in the clock digit location*), and finally;
- Self-testing.

If an error is detected, the error code will display whereby, the user can bypass the error by pressing the **Cancel** icon (⊗). Once the self-testing has completed checking for any errors, the thermostat will display the **Home** screen.

During the test, the configuration/test icon (🔧) blinks on the LCD screen indicating a test is in progress. Table 5 lists the sequence of tests that occurs:

**Note:** For a detailed list and descriptions of error codes, refer to the section, “Error Codes,” p. 48.

**Table 5. Error code test sequence**



Test Sequence	Error Code and Description
1	E4; <ul style="list-style-type: none"> <li>Operating range is 18 to 32 Vrms.</li> <li>Low error detection is less than 16.6, <math>\pm 8.5\%</math>.</li> <li>High error detection is greater than 34, <math>\pm 8.5\%</math></li> </ul>
2	E7; <ul style="list-style-type: none"> <li>Memory error (<i>write and read 0x55 and 0xAA failed</i>).</li> </ul>
3	E3; <ul style="list-style-type: none"> <li>Permanent data error. Access error or checksum error is detected.</li> </ul>
4	E0; <ul style="list-style-type: none"> <li>Temperature sensor error. Checks internal and/or external temperature sensor depending on setting of configuration option 0210.</li> </ul>
5	E1; <ul style="list-style-type: none"> <li>Humidity sensor error. Checks internal or external humidity sensor depending on setting of configuration option 0200.</li> </ul>
6	E5; <ul style="list-style-type: none"> <li>Real Time Clock (RTC) Error.</li> </ul>

## System Tests



The system test mode is used to run diagnostics on the thermostat to verify that the unit is functioning properly.

Referring to [Table 6, p. 22](#), to run a system test:

1. Remove the thermostat cover as shown in the section, "[Mounting the Backplate](#)," p. 10.
2. Press and hold the **Configuration** button (refer to [Figure 17, p. 21](#)) for 3 seconds. The configuration/test icon (  ) displays and the thermostat is now in **Configuration Setup Mode**.
3. Press and hold the **Configuration** button for 3 seconds again to activate **System Test Mode** indicated by the blinking parameter/test icon. When activating system test mode, the first system test number displayed is always 01.

The test number is changed with the Up (  ) or Down (  ) arrows in the center of the display screen.

**Note:** The **OK** button (  ) functions the same as the Up arrow and steps to the next higher test number.

The test value is changed with the Up (  ) or Down (  ) arrows on the right-hand side of the display screen.

**Note:** Changing a test value will start/stop the test as described in [Table 6](#). Refer to [Figure 17](#) for arrow locations and [Table 6, p. 22](#) for a list of test values and test value descriptions.

4. Exit the **System Test Mode** and return to the **Home** screen by:
  - a. Pressing the **Configuration** button momentarily (less than 3 seconds).
  - b. Touching and holding  for 2 seconds.
  - c. Powering down the thermostat and then powering it up again.
  - d. Waiting for a 10-minute time out after the last touch.

When exiting **System Test Mode**, the system will run a software reset and return to the Operating Home screen. If test 15=1, the software reset will be preceded by a **Power-up Test** (refer to [Table 6, p. 22](#)).

**Figure 17. Configuration button and system test mode display**

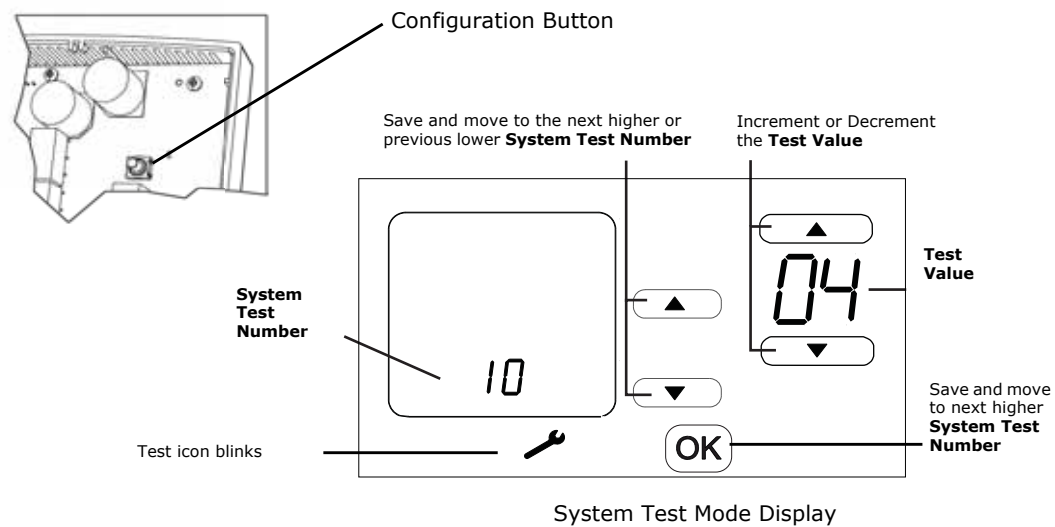



## Power, System Tests, and Software Reset

**Table 6. System tests and statuses**

Test Numbers	Test Value/Description
1; Heat System (W, W2)	<ul style="list-style-type: none"> <li>0= Heat stages turn <b>OFF</b></li> <li>1= Heat stage 1 turns <b>ON</b> and heat stage 2 turns <b>OFF</b></li> <li>2= Heat stage 2 turns <b>ON</b> and heat stage 1 turns <b>OFF</b></li> <li>3= Heat stage 1 and 2 turns <b>ON</b></li> </ul>
2; Cool System (Y, Y2)	<ul style="list-style-type: none"> <li>0= Cool stages turn <b>OFF</b></li> <li>1= Cool stage 1 turns <b>ON</b> and cool stage 2 turns <b>OFF</b></li> <li>2= Cool stage 2 turns <b>ON</b> and cool stage 1 turns <b>OFF</b></li> <li>3= Cool stage 1 and 2 turns <b>ON</b></li> </ul>
3; Fan System (G)	<ul style="list-style-type: none"> <li>0= Fan turns <b>OFF</b></li> <li>1= Fan turns <b>ON</b></li> </ul>
4; Changeover Valve (O/B)	<ul style="list-style-type: none"> <li>0= Changeover valve turns <b>OFF</b></li> <li>1= Changeover valve turns <b>ON</b></li> </ul>
5; TOD/Economizer System (A)	<ul style="list-style-type: none"> <li>0= TOD/Economizer turns <b>OFF</b></li> <li>1= TOD/Economizer turns <b>ON</b></li> </ul>
6; Dehumidify Relay (Dh)	<ul style="list-style-type: none"> <li>0= Dh relay turns <b>OFF</b></li> <li>1= Dh relay turns <b>ON</b></li> </ul>
7; LCD Full Segment	<ul style="list-style-type: none"> <li>0= No action</li> <li>1= Odd segments turn <b>ON</b>, even segments turn <b>OFF</b></li> <li>2= Even segments turn <b>ON</b>, odd segments turn <b>OFF</b></li> <li>3= Full segment turns <b>ON</b></li> </ul> <p><b>Note:</b> User will have a 1-second delay to scroll to values 1, 2, and 3. Then, the selected segment test will run for 5 seconds.</p>
8; Touch Keys	<ul style="list-style-type: none"> <li>0= No action</li> <li>1= Test touch keys</li> </ul> <p><b>Note:</b> Test value 1 will activate all touch areas on the display. The user can turn off each activated touch area, one at a time, until all are turned off or touch <b>Cancel</b> to exit the test.</p>
9; Temperature for Outdoor/Remote, S1/S2 Sensor	<ul style="list-style-type: none"> <li>0= Display current temperature in Fahrenheit</li> <li>1= Display current temperature in Celsius</li> </ul>
10; Temperature for Internal Sensor	<ul style="list-style-type: none"> <li>0= Display current temperature in Fahrenheit</li> <li>1= Display current temperature in Celsius</li> </ul>
11; Humidity for External Hs/Hp Sensor	<ul style="list-style-type: none"> <li>0= Display current humidity setpoint</li> <li>1= Display current humidity</li> </ul>
12; Humidity for Internal Sensor	<ul style="list-style-type: none"> <li>0= Display current humidity setpoint</li> <li>1= Display current humidity</li> </ul>
13; Software Version	<ul style="list-style-type: none"> <li>0= No action</li> <li>1= Software revision number</li> </ul> <p><b>Note:</b> Test value 1 displays the software revision number for 3 seconds and then returns to test mode.</p>
14; Filter	<ul style="list-style-type: none"> <li>0= No action</li> <li>1= Set filter countdown timer to zero (0) to display filter icon after exiting system test mode</li> </ul>
15; Run Power-up	<ul style="list-style-type: none"> <li>0= Power-up test <b>OFF</b> (power-up test <i>will not run</i> when exiting test mode)</li> <li>1= Power-up test <b>ON</b> (power-up test <i>will run</i> when exiting test mode)</li> </ul> <p><b>Note:</b> The value 0 does not affect normal power-up.</p>

## Software Reset

A watchdog timer recovers the system in the event of a software or hardware hang up or malfunction. The thermostat will reboot and run power-up tests if one of the following problems is detected:

- Exiting **System Test Mode** (power test only runs if test mode 15 is set to 1).
- The main variables are out of range during run time such as configuration data, active setpoint, RTC data, fan mode, or operation mode (EEPROM content is restored to default for this error detection).
- When three (3) cycles of power loss is detected and power returns.
- Any recoverable software hang up occurs due to hardware component or software bug.

# Configuration Option Setup

This section provides information about changing system configurations. For reference, [Table 7, p. 24](#), lists the Configuration Option Numbers, corresponding values, and descriptions.

## NOTICE

### Adverse Control System Behavior!

**Improper configuration setup could cause unwanted, possibly adverse control system behavior. Be sure to configure the thermostat according to your system type.**

To change the installation configuration:

1. Apply electrical power to the thermostat.
2. Refer to [Table 7, p. 24](#) to determine the correct configuration options. For convenience, either print out this table or write down the selections and other notes listed.
3. Activate **Configuration Option Setup** mode by:

## ⚠ WARNING

### Live Electrical Components!



**The circuit board is energized. Have a qualified licensed electrician or other individual who has been properly trained in handling live electrical components perform this step. Failure to follow all electrical safety precautions when exposed to live electrical components could result in death or serious injury.**

- a. Removing the thermostat cover as shown in the section, "[Mounting the Backplate](#)," p. 10.
- b. Pressing and holding the **Configuration** button for 3 seconds. The configuration wrench icon  displays solid along with the configuration option number and value (refer to [Figure 18](#) below).

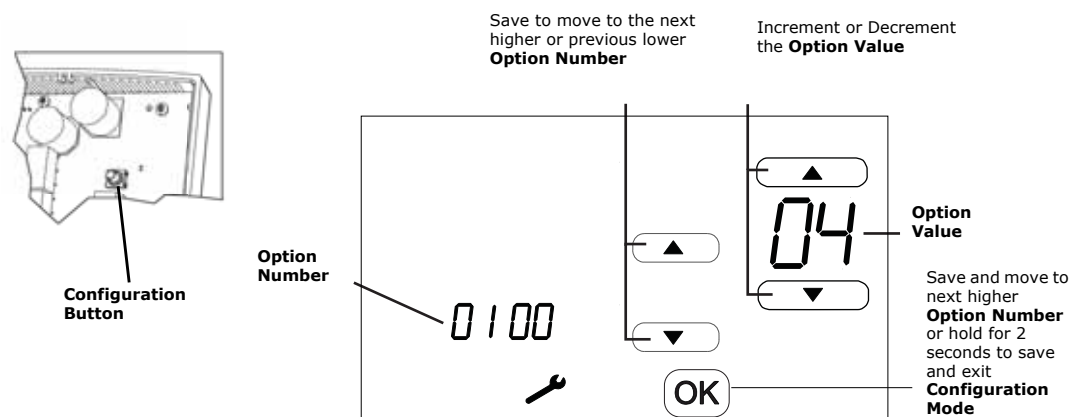

**Figure 18. Configuration button and configuration mode display**



**Note:** Configuration mode automatically ends if no buttons are pressed for 10 minutes.

4. Next, press the center  or  (as shown) to increment or decrement the **Option Number**.

**Note:** Changing the Option Number with the up/down arrows will also Save the Option Value. In addition, the OK will increment the Option Number and Save the Option Value.

5. Press the right side  or  (as shown) to increment or decrement the **Option Value**.
6. To **Save** settings, exit **Configuration Mode** and return to the **Home** screen:
  - Push the configuration button momentarily as shown in [Figure 18](#)
  - Touch and hold  for 2 seconds
  - A 10-minute time out after the last touch in **Configuration Mode**

# Installation Options

**Table 7. Installer configuration setup menu**

Opt. No.	Name	Def	Values/Descriptions	Notes
0100	Temperature indication/ Resolution	0	<ul style="list-style-type: none"> <li>• 0= °F, 1 degree resolution</li> <li>• 1= °F, 0.5 degree resolution</li> <li>• 2= °C, 1 degree resolution</li> <li>• 3= °C with 0.5 degree resolution</li> <li>• 4= °C with 0.1 degree resolution</li> </ul>	This setting affects indoor temperature display and setpoint display resolutions. Outdoor temperature display area is always ±1 resolution for both F and C. Refer to Option 0210.
0110	Clock Format	12	<ul style="list-style-type: none"> <li>• 12= 12-hour clock</li> <li>• 24= 24-hour clock</li> </ul>	
0120	Year	11	<ul style="list-style-type: none"> <li>• 11-99</li> </ul>	Available year range: 2011-2099. This value is updated to the real time clock after setting. Day of the week is updated automatically.
0121	Month	1	<ul style="list-style-type: none"> <li>• 1-12</li> </ul>	This value is updated to the real time clock after setting. Day of the week is updated automatically.
0122	Day	1	<ul style="list-style-type: none"> <li>• 1-31</li> </ul>	Month dependent: this value is updated to the real time clock after setting. Day of the week is updated automatically.
0125	Daylight Savings	2	<ul style="list-style-type: none"> <li>• 0= Disabled</li> <li>• 1= US (1987), changeover at 2:00am</li> <li>• 2= US (2007), changeover at 2:00am</li> <li>• 3= Europe, changeover at 1:00am</li> <li>• 4= Manual, changeover at 2:00am</li> </ul>	
0126 0127 0128 0129	<ul style="list-style-type: none"> <li>• Spring Ahead Month</li> <li>• Spring Ahead Day</li> <li>• Fall Back Month</li> <li>• Fall Back Day</li> </ul>	<ul style="list-style-type: none"> <li>• 03</li> <li>• 01</li> <li>• 11</li> <li>• 01</li> </ul>	<ul style="list-style-type: none"> <li>• 01-12</li> <li>• 01-31</li> <li>• 01-12</li> <li>• 01-31</li> </ul>	Options available only if 0125 is set to 4.
0130	System Selection	8	<ul style="list-style-type: none"> <li>• 1= 1H/1C (Conv) 1st Stage Heat (W), 1st Stage Comp (Y), Fan (G)</li> <li>• 2= 1H/1C (HP) 1st Stage Comp (Y), Changeover (O/B), Fan (G)</li> <li>• 3= 1H (Conv) 1st Stage Heat (W), without fan</li> <li>• 4= 1H (Conv) 1st Stage Heat (W), Fan (G)</li> <li>• 5= 1C (Conv) 1st Stage Comp (Y), Fan (G)</li> <li>• 6= 2H/1C (HP) 1st Stage Comp (Y), Changeover (O/B), Auxiliary Heat (W1), Fan (G)</li> <li>• 7= 2H/2C (Conv) 1st &amp; 2nd Stage Heat (W,W2), 1st &amp; 2nd Stage Comp (Y,Y2), Fan (G)</li> <li>• 8= 2H/1C (Conv) 1st &amp; 2nd Stage Heat (W,W2), 1st Stage Comp (Y), Fan (G)</li> <li>• 9= 1H/2C (Conv) 1st Stage Heat (W), 1st &amp; 2nd Stage Comp (Y,Y2), Fan (G)</li> <li>• 10= 2H/2C (HP) 1st &amp; 2nd Stage Comp (Y,Y2), Changeover (O/B), Fan (G)</li> <li>• 11= 3H/2C (HP) 1st &amp; 2nd Stage Comp (Y,Y2), Changeover (O/B), Auxiliary Heat (W1), Fan (G)</li> </ul>	
0140	Schedule Options	1	<ul style="list-style-type: none"> <li>0=Non-programmable</li> <li>1= Programmable</li> </ul>	
0150	TOD/Economizer Output (Terminal A)	0	<ul style="list-style-type: none"> <li>• 0= Unused</li> <li>• 1= TOD energizes terminal <b>A</b> during occupied period, not during unoccupied period.</li> <li>• 2= Economizer energizes terminal <b>A</b> during a call for cool.</li> </ul>	TOD is not available in Non-programmable Mode. (Refer to Option 0140)
0151	Heat Fan Operation	0	<ul style="list-style-type: none"> <li>0= System controls fan</li> <li>1= Thermostat controls fan</li> </ul>	Only shown for conventional system with heat stages and fan capability. For heat pump, the fan relay operates with thermostat control.
0153	Reversing Value O/B	0	<ul style="list-style-type: none"> <li>0= O/B <b>ON</b> when call for cool</li> <li>1= O/B <b>ON</b> when call for heat</li> </ul>	Only shown for heat pump systems.
0160	Cycles Per Hour (CPH) [First Stage Compressor]	3	1-5	Only for systems with cool or HP stage. (Refer to Option 0130.) Selection in this stage changes 2nd stage cool default CPH.
0161	CPH (Second Stage Compressor)	3	1-5	Only for systems with 2-cool or HP stages. (Refer to Option 0130.)



**Table 7. Installer configuration setup menu (continued)**

Opt. No.	Name	Def	Values/Descriptions	Notes
0162	CPH (First Stage Conventional Heat)	5	1-10	Only for conventional systems with heat stages. (Refer to Option 0130.) Selection in this stage changes default CPH of 2nd stage heat.
0163	CPH (Second Stage Conventional Heat)	9	1-10	Only for conventional systems with two stages of conventional heat.
0164	CPH for Auxiliary Heat	9	1-10	Only shown for 2H/1C HP or 3H/2C HP systems. (Refer to Option 0130.)
0165	CPH for Emergency Heat	9	1-10	Only shown for 2H/1C HP or 3H/2C HP systems. (Refer to Option 0130.)
0170	Continuous Backlight	0	0= Backlight <b>ON</b> time is limited      1= Backlight <b>ON</b> continuously	
0180	Changeover	1	0= Manual      1= Auto	Only for systems with both heat and cool stages. (Refer to Option 0130.)
0181	Deadband	3	<ul style="list-style-type: none"> <li>• 2= 2°F (1°C)</li> <li>• 3= 3°F (1.5°C)</li> <li>• 4= 4°F (2.0°C)</li> <li>• 5= 5°F (2.5°C)</li> <li>• 6= 6°F (3.0°C)</li> <li>• 7= 7°F (3.5°C)</li> <li>• 8= 8°F (4.0°C)</li> <li>• 9= 9°F (4.5°C)</li> </ul>	Only applies to auto or manual changeover systems. (Refer to Option 0180.)
0182	Minimum Compressor Off Time	5	<ul style="list-style-type: none"> <li>• 0= 0 minutes</li> <li>• 1= 1 minute</li> <li>• 2= 2 minutes</li> <li>• 3= 3 minutes</li> <li>• 4= 4 minutes</li> <li>• 5= 5 minutes</li> </ul>	Only for systems with cool stage or heat pump. (Refer to Option 0130.) This setting will extend the compressor <b>OFF</b> time beyond any other delays incorporated in the Heat/Cool software algorithm.
0190	Power Supply Frequency	0	0= 60 Hz      1= 50 Hz	Power supply input is 24 Vac nominal at either 60 Hz or 50 Hz.
0200	Dehumidify Sensor Selection	1	<ul style="list-style-type: none"> <li>• 0= Humidity display and function is disabled</li> <li>• 1= Internal humidity sensor enabled</li> </ul> 2= External humidity sensor enabled	For external humidity control, a 4-20 mA humidity sensor must be connected to the Hp and Hs terminals to avoid error code <b>E1</b> .
0205	Dehumidification Control	0	0= Active Control      1= Passive Control	Active control toggles Dh output terminal <b>ON</b> and <b>OFF</b> as specified by the dehumidify algorithm and is used with a device having its own dehumidification equipment. Passive control runs cool mode for up to 1 extra minute whenever there is a call for cool and dehumidification.
0206	Internal Humidity Offset Adjustment	0	-9% to 9% in 1% increments	Allows adjustment of the internal relative humidity reading to account for accuracy, tolerance, and potential drift. FW should use the adjusted value for display and humidity control.
0207	External Humidity Offset Adjustment	0	-9% to 9% in 1% increments	Allows adjustment of the external relative humidity reading to account for accuracy, tolerance, and potential drift. FW should use the adjusted value for display and humidity control.
0210	Temperature Sensor Selection	0	<ul style="list-style-type: none"> <li>• 0= Internal sensor only (10k)</li> <li>• 1= Internal sensor for H/C control (outdoor for display only) [10k]</li> <li>• 2= internal sensor for H/C control (outdoor for Compr/Aux lockout control)[10k]</li> <li>• 3= Remote indoor sensor for H/C control (10k)</li> <li>• 4= Use average temperature = (local+S1/S2)/2 for H/C control.</li> </ul>	Setting 2 applies only to HP systems and is disabled on all conventional systems.  For setting 1, 2, or 4; if either temperature sensor is out of range, then the <b>E0</b> error code will display.
0220	Heat Pump Compressor Lockout Point	0	<ul style="list-style-type: none"> <li>• 0= None</li> <li>• 15= 15°F (-9.5°C)</li> <li>• 20= 20°F (-6.5°C)</li> <li>• 25= 25°F (-4.0°C)</li> <li>• 30= 30°F (-1.0°C)</li> <li>• 35= 35°F (1.5°C)</li> <li>• 40= 40°F (4.5°C)</li> <li>• 45= 45°F (7.0°C)</li> </ul>	Only for heat pump systems with more heat stages than cool stages and remote outdoor control sensor. (Refer to Option 0130 and Option 0210.) <b>Note:</b> A 5°F (2.5°C) deadband between heat pump and auxiliary lockout will be enforced.
0221	Heat Pump Auxiliary Lockout Point	0	<ul style="list-style-type: none"> <li>• 0= None</li> <li>• 40= 40°F (4.5°C)</li> <li>• 45= 45°F (7.0°C)</li> <li>• 50= 50°F (10.0°C)</li> <li>• 55= 55°F (13.0°C)</li> <li>• 60= 60°F (15.5°C)</li> </ul>	Only for heat pump systems with more heat stages than cool stages and remote outdoor control sensor. (Refer to Option 0130 and Option 0210.) <b>Note:</b> A 5°F (2.5°C) deadband between heat pump and compressor lockout will be enforced.
0230	Temporary Override Duration Limit	3	<ul style="list-style-type: none"> <li>• 0= zero hours</li> <li>• 1= one hour</li> <li>• 2= two hours</li> <li>• 3= three hours</li> <li>• 4= four hours</li> </ul>	Used for temporary override (TOV) starting duration time. Setting of zero <b>does not</b> disable TOV.



Table 7. Installer configuration setup menu (continued)

Opt. No.	Name	Def	Values/Descriptions	Notes
0231	Starting Default Number of Periods	2	2= two periods 4= four periods	Provides starting default number of periods for all days of the week.
0232	Starting Default Period Occ/Unocc Definitions	4	<p><u>If option #0231 is set to 2</u></p> <p>Day—Night</p> <ul style="list-style-type: none"> <li>• 0= UnOcc—UnOcc</li> <li>• 1= UnOcc—Occ</li> <li>• 2= UnOcc—UnOcc</li> <li>• 3= UnOcc—Occ</li> <li>• 4= Occ—UnOcc</li> <li>• 5= Occ—Occ</li> <li>• 6= Occ—UnOcc</li> <li>• 7= Occ—Occ</li> <li>• 8= UnOcc—UnOcc</li> <li>• 9= UnOcc—Occ</li> <li>• 10= UnOcc—UnOcc</li> <li>• 11= UnOcc—Occ</li> <li>• 12= Occ—UnOcc</li> <li>• 13= Occ—Occ</li> <li>• 14= Occ—UnOcc</li> <li>• 15= Occ—Occ</li> </ul> <p><u>If option #0231 is set to 4</u></p> <p>Morn—Day—Evening—Night</p> <ul style="list-style-type: none"> <li>• 0= UnOcc—UnOcc—UnOcc—UnOcc</li> <li>• 1= UnOcc—UnOcc—UnOcc—Occ</li> <li>• 2= UnOcc—UnOcc—Occ—UnOcc</li> <li>• 3= UnOcc—UnOcc—Occ—Occ</li> <li>• 4= UnOcc—Occ—UnOcc—UnOcc</li> <li>• 5= UnOcc—Occ—UnOcc—Occ</li> <li>• 6= UnOcc—Occ—Occ—UnOcc</li> <li>• 7= UnOcc—Occ—Occ—Occ</li> <li>• 8= Occ—UnOcc—UnOcc—UnOcc</li> <li>• 9= Occ—UnOcc—UnOcc—Occ</li> <li>• 10= Occ—UnOcc—Occ—UnOcc</li> <li>• 11= Occ—UnOcc—Occ—Occ</li> <li>• 12= Occ—Occ—UnOcc—UnOcc</li> <li>• 13= Occ—Occ—UnOcc—Occ</li> <li>• 14= Occ—Occ—Occ—UnOcc</li> <li>• 15= Occ—Occ—Occ—Occ</li> </ul>	Occupancy setting can be changed during scheduling for each period/day.
0233	Days Options for Scheduling Mode	3	<ul style="list-style-type: none"> <li>• 0= 1 day; Mo-Su all days share the same schedule</li> <li>• 1= 5+1+1 days; Mo-Fr share a schedule. Sa and Su each have an independent schedule</li> <li>• 2= 5+2 days; Mo-Fr share a schedule. Sa-Su share a schedule.</li> <li>• 3= 7 days; Each day has an independent schedule</li> </ul>	Any value toggle of Option 0233 will reset the schedule to the default values of Options 0231 and 0232, and in addition, return the schedule to default values.
0240	Heat Temperature Range	90	40–90; 40°F to 90°F 4–32; 4°C to 32°C	Only for systems with heat stage. (Refer to Option 0130.)
0241	Cool Temperature Range	50	50–99; 50°F to 99°F 10–37; 10°C to 37°C	Only for systems with cool stage. (Refer to Option 0130.)
0260	Temperature Display Offset	0	<ul style="list-style-type: none"> <li>• -3= -3°F (-1.5°C)</li> <li>• -2= -2°F (-1.0°C)</li> <li>• -1= -1°F (-0.5°C)</li> <li>• 0= None</li> <li>• 1= 1°F (0.5°C)</li> <li>• 2= 2°F (1.0°C)</li> <li>• 3= 3°F (1.5°C)</li> </ul>	Only applies to control temperature and display temperature for internal and indoor remote sensor. Does not apply to outdoor temperature for display.
0270	Extended Fan-on Time Heat	0	0= OFF 90= ninety seconds	This option is not available if Option 0151=0 or if system is cool only. (Refer to Option 0130.)
0271	Extended Fan-on Time Cool	0	0= OFF 40= forty seconds	This option is not available for systems with heat only. (Refer to Option 0130.)
0275	Filter Change Indicator	1	<ul style="list-style-type: none"> <li>• 0= OFF</li> <li>• 1= 30 days</li> <li>• 3= 90 days</li> <li>• 4= 120 days</li> <li>• 6= 180 days</li> <li>• 12= 365 days</li> </ul>	Filter change disabled in <b>OFF</b> . Timer values start on first power-up or reset of an active filter change icon.
0300	Restore Factory Defaults	0	0= No 1= Yes	No= No action; Yes= Resets all parameters to default except calendar/daylight savings time/system selection.

# Operation

If configured properly, the touch-screen programmable thermostat will control HVAC equipment to maintain room temperature automatically. This section provides general descriptive and procedural information intended for daily operation.

## Thermostat Icon Descriptions

The illustration below provides a description of all icons for the thermostat. Bubbled letters in red correspond to the letters indicated in each section title.

**Note:** In normal operations, not all icons are visible.

Figure 19. Icon descriptions

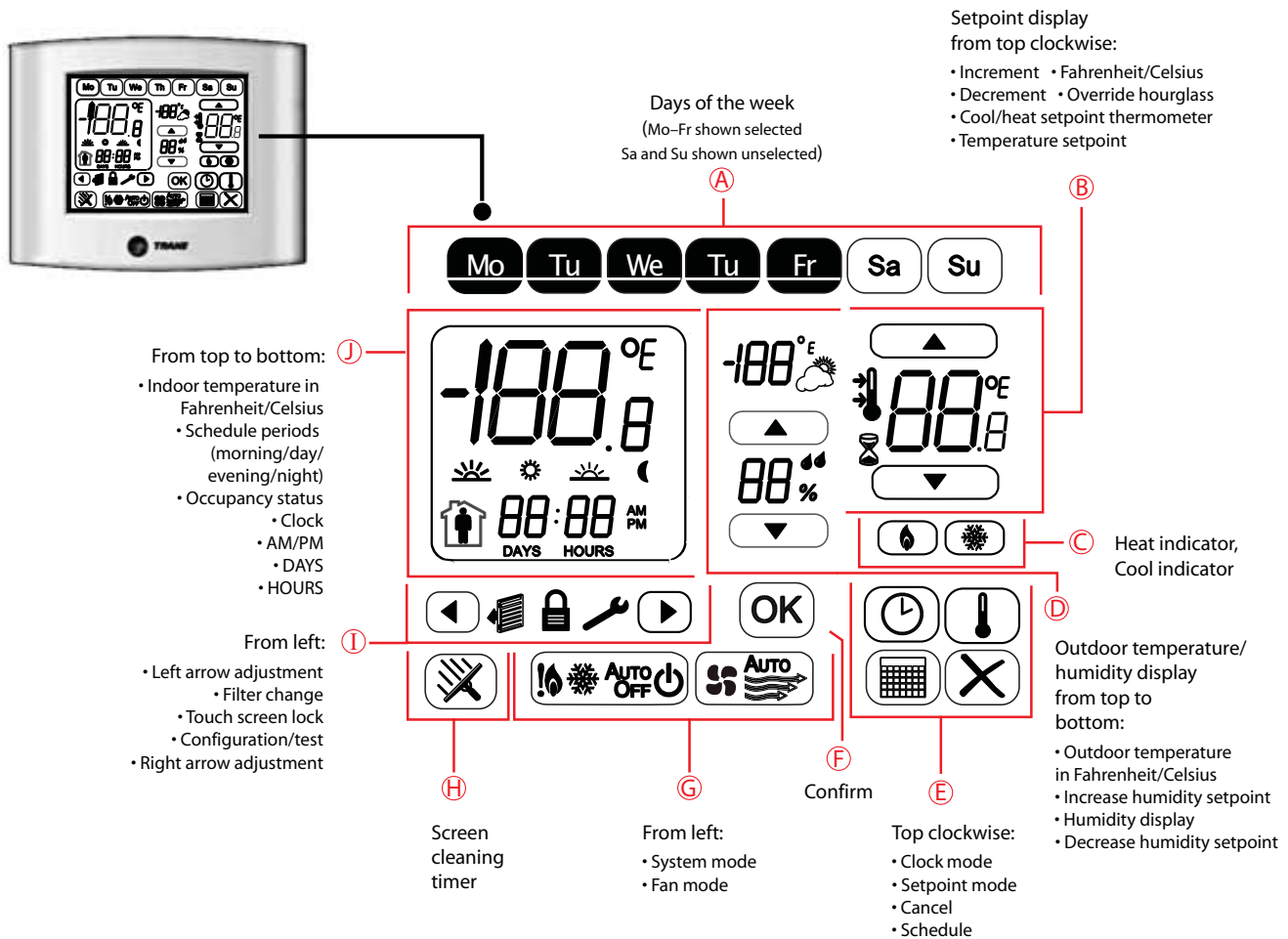



# Functions



There are common functions on the programmable thermostat that require initial setting or changing. This section describes the following setup modes:

- Time setup, dehumidify setup, and system mode setup
- Fan mode and temporary override (TOV) mode
- Schedule setup
- Table of default settings and worksheet





**Note:** The touch screen can be locked out to prevent unauthorized personnel from changing settings. A lockout will disable changes to System, Fan, Scheduling, Time and TOV. If the lock icon (  ) is displayed on the LCD screen, the user will need to unlock the touch screen to allow changes (refer to the section, "System Lockout," p. 41).

## Time Setup

To set or change the time:

1. From the **Home** screen, touch  to activate the **Time Setting Mode**. The LCD screen displays hours:minutes (with the hours blinking to indicate it is selected) and either AM or PM (AM/PM is not shown for 24-hour clock) as shown: 

**Note:** To change clock to either 12-hour or 24-hour readout, refer to Option Number 0110 in Table 7, p. 24).

2. Touch either  or  to switch between hours or minutes.
3. Touch  or  to increment or decrement the hours/minutes. Touch and hold either button for more than 1 second to fast scroll through values.
4. Touch  to save and exit **Time Setting Mode**.



**Note:** A 20-second time out will also save and exit Time Setting Mode.

5. Touch  to exit without saving any changes.

## Dehumidify Setup

**Note:** This function is displayed only for systems configured with dehumidify enabled. (Refer to Configuration Option Number 0200).

To set or change dehumidification:

1. Touch  to activate the **Dehumidify Setting Mode**. The LCD screen displays the current humidity setpoint with adjustment arrows.
2. Touch  or  to increment or decrement the humidity setpoint by 1% increments. Touch and hold either button for more than 1 second to fast scroll through values.

**Note:** Dehumidification setpoint can be adjusted from 30% to 80%.

3. Touch  to save and exit **Dehumidify Setting Mode**.

**Note:** A 20-second time out will also save and exit Dehumidify Setting Mode.

4. Touch  to exit without saving any changes.

## System Mode Setup E F G

**Note:** If unable to change the system mode to a desired setting, check the system type setting and the manual/auto-changeover setting (refer to the section, “Configuration Option Setup,” p. 23) to verify how the thermostat is configured with heat and cool modes, and that it permits manually changing them. (Refer to Configuration Option Numbers 0130 and 0180).

Depending upon the model and system type, the thermostat can be set to one of five modes: **Cooling, Heating, Emergency Heat, AUTO, or OFF.**

**Note:** All system icons may not be available— this is configuration setup dependent.

- Cooling Mode;** cools the room to bring it down to the cooling setpoint.
- Heating Mode;** heats the room to bring it up to the heating setpoint.
- Emergency Heat Mode;** heats the room using the emergency heat mode equipment.
- AUTO Mode;** switches automatically between heating and cooling modes as required.
- OFF Mode;** turns **OFF** both heat and cool modes regardless of the room temperature. **OFF** mode also disables the fan relay.

To set the system mode:

- Touch area to activate the **System Mode Setup**. All system mode settings available are visible with the current system setting blinking. Each touch in the system selection box will step to the next available setting as shown below.

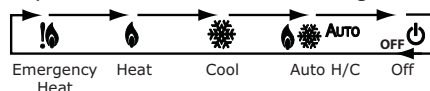

- Choose a system mode and then either touch or a 20-second time out will save the system mode setting and return to the **Home** screen.

**Note:** Touching another active area on the display screen (such as clean screen, clock, humidity, or schedule) will also save the system mode setting selected in Step 2 and activate the newly selected system setting.

Touching **Cancel** () will exit system mode setup without saving any changes.

## Fan Mode E F G

**Note:** The fan is only displayed on systems configured with the fan enabled. If disabled, then the fan icon on the LCD screen is not visible. The Fan mode is typically configured in Schedule Setup. Fan mode changes from the Home screen initiates an override (TOV) [refer to the section, “Schedule Setup,” p. 31].

There are two fan modes. Each are indicated by an icon on the display:

- Fan AUTO Mode;** turns the fan **ON** and **OFF** as needed according to equipment configuration.
- Fan ON Mode;** runs the fan continuously.

To enter fan mode:

- Touch area to activate the **Fan Display Mode** and the active fan mode will blink.

**Note:** Touching , , another active area, or a 20-second time out will return to the **Home** screen without making changes to the fan.

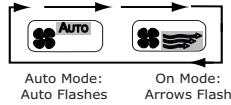

- Next, touch in the fan selection box to put the thermostat into **TOV Temporary Override Mode** and to step to the next available setting as shown below.



- Refer to the next section, **Temporary Override (TOV) Setup** to set overrides or touch  to cancel and return to the **Home** screen.



## Temporary Override (TOV) Setup





TOV allows the user to temporarily override the scheduled temperature setpoint and/or fan settings. There are two ways to enter TOV Mode from the Home screen:





- Quick TOV:** Touch the Occ () or Unocc () icon from the Home screen. A TOV session will start up using the last occupied schedule setpoint settings, the last occupied fan setting, and the default TOV time period (*Option Number 0230*). Touch **OK** or wait for a 20-second time out to put the thermostat into quick **TOV Active Mode**; **OR**
- User Configurable TOV:** Touch either the Up or Down arrow to blink the *setpoint* for 20 seconds. Touch of the Up or Down arrows within 20 seconds to change the setpoint and put the thermostat into TOV Setpoint Change Mode; **OR**

Touch the Fan to blink the present Fan setting for 20 seconds. Touch the Fan area within 20 seconds to change the Fan setting and put the thermostat into **TOV Setpoint Change Mode**.

In **TOV Setpoint Change Mode**, further adjustments can be made to the setpoint or Fan mode with the Up, Down, or Fan areas.

**Note:** For Auto H/C systems, use the cool mode icon () or the heat mode icon () to toggle between cool and heat setpoints respectively.

- To adjust the TOV time period:
  - Touch the clock icon () to enter **TOV Time Setup Mode**. The left/right arrow ( or ) will toggle between Days/Hours and the middle Up/Down arrows ( or ) will increment or decrement the time.
 



**Note:** A second touch of the clock icon () will put the thermostat into **Hold Mode** which holds the TOV settings indefinitely until canceled by the user. Additional touches of the clock icon () will toggle the thermostat between **DAYS/HOURS** and **Hold**.
  - Toggle back to readjust the setpoint(s) by touching the thermometer icon ()
  - Touch  area to activate the desired settings. Active TOV is indicated by a solid non-blinking hourglass ()

**Note:** Desired settings are also activated after a 20-second time out.

- To **Cancel** the TOV time period, touch  at any time to cancel and exit **TOV Mode**.

### General Notes:

- TOV setup has three modes: **TOV Setpoint Setup**, **TOV Time Setup**, and **TOV Active**.
- If Fan is enabled, then TOV Fan setting can be changed in either **TOV Setpoint Mode** or **TOV Time Setting Mode**.
- If a TOV is in active status, then those TOV settings become the starting setpoints if entering into a new User Configurable TOV session.
- Fan icons do not display on the LCD screen if the system is not configured for fans.
- The  confirm icon is not displayed when the user is in **TOV Active Mode**.

- When starting/activating TOV, the  displays solid indicating that TOV is ACTIVE.
- **Quick TOV Active Mode** will show Occ () icon while User Configurable **TOV Active Mode** Occ/UnOcc will be blank.
- In **Quick TOV Active Mode**, the typical display will show the TOV time remaining as HH:MM (Hours:Minutes) for 45 seconds. After the 45 seconds, the display will cycle to Time of Day with AM/PM for 10 seconds, followed by HH:MM for 5 seconds, and continue repeating Time of Day and HH:MM until time expires or Cancel.
- In **User Configurable TOV Active Mode**, the typical display will show DD:HH (DD is days and HH is Hours). After the 45 seconds, the display will cycle to Time of Day with AM/PM for 10 seconds, followed by Days (for 3 seconds) if 1 day or more TOV time left, HH:MM (for 5 seconds), and continue repeating Time of Day, Days, and HH:MM until time expires or Cancel.
- During a power outage, if the unit was in **TOV Mode**, it will return to the last TOV settings when power is returned.
- TOV is not available in non-programmable mode (*refer to Installation Option Number 0140*).

## Schedule Setup















Schedules can be used to set the day/time/periods and to set the fan and setpoints. This section describes the following:

- Schedule display mode
- Day/period/time schedule change mode
- Setpoint/fan schedule change mode

When setting either the day/period/time schedule or setpoint schedule, refer to [Table 8, p. 35](#) for default settings and worksheet.

### Schedule Display Mode

This display mode is used to view current settings such as setpoints, periods, and day of the week as shown in the illustration below. When in **Schedule Display Mode**, the user cannot change settings.

- From the **Home** screen, touch  to enter Schedule Display mode.
- Touch any of the        icons to view the day or day group schedule. The day selected is displayed in an inverse graphics (similar to the **Tu** weekday as shown). Only one day or day group can be selected at one time. Day groups are determined by *Installation Option Number 0233*.
- Touch any     to view its current schedule. The current period will blink.
- For Auto H/C systems, touch  or  to toggle between Cool or Heat setpoints. Either icon will blink depending on which setpoint is being displayed.
- Touch cancel () to exit **Schedule Display** mode or after 20-second time out.

- Touch blinking  to proceed to the next section, **Day/Time/Period Schedule Change Mode**, before the 20-second time out. Time out changes to 60 seconds for the change modes.

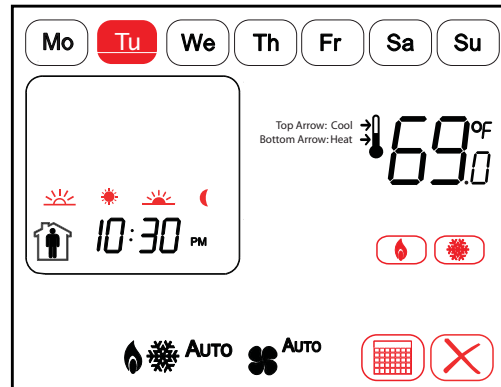

### Day/Period/Time Schedule Change Mode (A) (B) (E) (J)











This mode is used to select the day, day group, multiple day groups, period times, fan, and occupancy. The default settings, *Number of Periods*, *Occupancy Settings*, and *Day Groups*, are configured using **Configuration Option Numbers 0231, 0232, and 0233 respectively**.

To change day/period/time:

1. First day or day group selected is carried over from the schedule display mode. To change/add multiple days or day groups, touch the desired weekday icon (Mo, Tu, We, and so on). The day of day groups are toggled **ON** or **OFF** with each touch.

**Note:** The first single day or day group selected is the master. Any additional day or day groups selected are temporarily loaded with the master values. Any changes will apply to all selected day or day groups.

**Note:** Day or Day Groups can only be selected in **Day/Period/Time Schedule Change Mode**.

2. Touch     to select the period of day.
3. To change the start time of the selected period, touch either  or  to increment or decrement the time in 15-minute increments.
4. Touch  to change the occupancy setting to either occupied () or unoccupied (), if desired.
5. If Fan is enabled, touch the Fan area to change to desired fan setting.
6. Repeat steps 1 through 5 to set the start times and occupancy for all days/periods.
7. Touch  to proceed to the next section, **Setpoint/Fan Schedule Mode**, before the 60-second time out.

**Note:** Touch  and  to toggle between **Day/Period/Time Schedule Change Mode** and **Setpoint/Fan Schedule Mode**.

**Note:** Selecting **OK** will save changes and a **Cancel** will remove any changes since the last save and then exit schedule change mode.



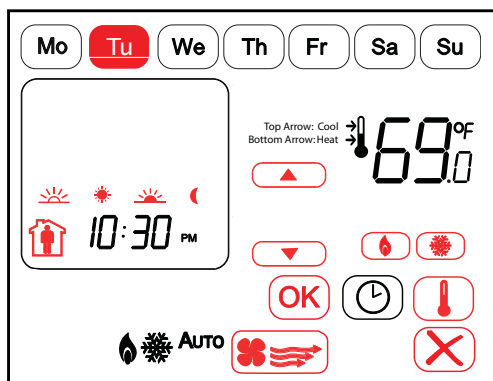

The following are the available day group schedules that can be configured with Installation Option Number 0233:

- All Days [**default**]: (Mo Tu We Th Fr Sa Su)
- Five days, plus one day, plus one day: (Mo Tu We Th Fr) (Sa) (Su)
- Five days, plus two days: (Mo Tu We Th Fr) (Sa Su)
- Seven individual days: (Mo) (Tu) (We) (Th) (Fr) (Sa) (Su)

### Setpoint/Fan Schedule Change Mode ⓑ ⓒ ⓔ ⓕ ⓙ

This mode is used to set the heat and/or cool setpoint, occupancy, and the fan settings for the selected day, day group, or multiple day groups. Day or Day Groups cannot be changed in this mode. Default settings are shown in [Table 8, p. 35](#).

To change the setpoint/fan schedule:

1. From the previous section, touch to select the period of day.
2. To change the setpoint of the selected period, touch either or to increment or decrement the setpoint temperature.
3. For Auto H/C systems, touch or to toggle between cool setpoint and heat setpoint.
4. Touch area to change the fan mode for the selected period.
5. Touch to change the occupancy setting for the selected period to either occupied () or unoccupied (), if desired.
6. Repeat steps 1 through 5 to set all fan, occupancy, and temperature setpoints for each period as desired.
7. When all changes are completed, touch to save settings. A second touch of will exit out of **Schedule Change** mode, and return to the **Home** screen. A 60-second time out will also save.

**Note:** Day or day groups cannot be changed in **Setpoint/Fan Schedule Change Mode**. The user must return to **Day/Period/Time Schedule Change Mode** to select different days or day groups. Touch and to toggle between **Day/Period/Time Schedule Change Mode** and **Setpoint/Fan Schedule Mode**.

**Note:** Touch and to toggle between **Day/Period/Time Schedule Change Mode** and **Setpoint/Fan Schedule Mode**.

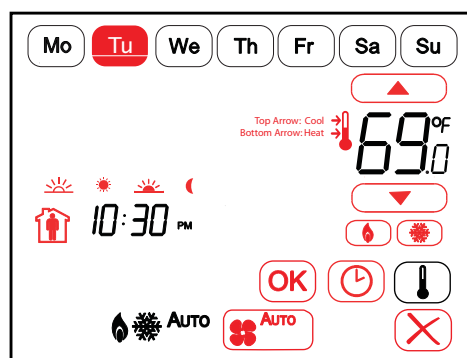

**General Notes for All Schedule Modes**

- Touching **Cancel** (⊗) will cause all changes after the last save to be lost, the display will return to the Home screen, and the system will return to the last save schedule settings.
- When any changes are made to the schedule, the first touch of **OK** will save changes and return to the last schedule changes mode. The second touch of **OK**, if no further changes are made, will exit **Schedule Change Mode** and return to the **Home** screen or **TOV**, if still active.
- Screens may vary depending on configuration settings.
- Schedule mode is not available in non-programmable mode (*Refer to Configuration Option Number 0140*).

**Table 8. Default settings and worksheet**

<i>Symbol Legend Listed Below</i>					
4-Period Defaults		6:00 AM	70°F (21.0°C)	78°F (25.5°C)	AUTO
		8:00 AM	62°F (16.5°C)	85°F (29.5°C)	AUTO
		6:00 PM	70°F (21.0°C)	78°F (25.5°C)	AUTO
		10:00 PM	62°F (16.5°C)	82°F (28.0°C)	AUTO
2-Period Defaults		8:00 AM	70°F (21.0°C)	78°F (25.5°C)	AUTO
		10:00 PM	62°F (16.5°C)	82°F (28.0°C)	AUTO
Monday		:	°	°	AUTO/
		:	°	°	AUTO/
		:	°	°	AUTO/
		:	°	°	AUTO/
Tuesday		:	°	°	AUTO/
		:	°	°	AUTO/
		:	°	°	AUTO/
		:	°	°	AUTO/
Wednesday		:	°	°	AUTO/
		:	°	°	AUTO/
		:	°	°	AUTO/
		:	°	°	AUTO/
Thursday		:	°	°	AUTO/
		:	°	°	AUTO/
		:	°	°	AUTO/
		:	°	°	AUTO/
Friday		:	°	°	AUTO/
		:	°	°	AUTO/
		:	°	°	AUTO/
		:	°	°	AUTO/
Saturday		:	°	°	AUTO/
		:	°	°	AUTO/
		:	°	°	AUTO/
		:	°	°	AUTO/
Sunday		:	°	°	AUTO/
		:	°	°	AUTO/
		:	°	°	AUTO/
		:	°	°	AUTO/
<b>Symbol Legend:</b> Morning          Day          Evening          Night          Time          Heat          Cool          Fan          ON					



## Other Thermostat Functions

The programmable thermostat has other functional features which provide more flexibility and control in its operation. Those features are:

- Heat/Cool indicator display (for both programmable and non-programmable thermostats (refer to the next section, “Heat/Cool Indicator Display” )
- Non-programmable mode
- Filter change
- Clean screen
- Local/remote/outdoor temperature display and control
- Local/remote humidity display and control
- System lock

### Heat/Cool Indicator Display

Setpoint display: when the system is set for only Heat or only Cool, there is no flame ( 🔥 ) or snowflake ( ❄️ ) icon under the setpoint value.

When the system is set to **AUTO** ( 🔥❄️<sup>AUTO</sup> ), the following applies:

- When the thermistor used for H/C control is above the Cool Setpoint, the Cool Setpoint will show on the display along with the snowflake ( ❄️ ) under the setpoint.
- When the thermistor used for H/C control is below the Heat Setpoint, the Heat Setpoint will show on the display along with the flame ( 🔥 ) under the setpoint.
- When the thermistor used for H/C control is between the Cool and Heat Setpoints (inclusive), the last active system setpoint (Cool or Heat) will show on the display.

When the system is set to **AUTO** ( 🔥❄️<sup>AUTO</sup> ), the blink rates for the snowflake ( ❄️ ) and flame ( 🔥 ) under the setpoint are as follows:

- When no Cool or Heat cycle is running and no compressor protection timer running, if the Heat Setpoint is showing, then the flame ( 🔥 ) under the setpoint will blink at 4.5 seconds **ON** and 1.75 seconds **OFF**.
- When no Cool or Heat cycle is running and no compressor protection timer running, if the Cool Setpoint is showing, then the snowflake ( ❄️ ) under the setpoint will blink at 4.5 seconds **ON** and 1.75 seconds **OFF**.
- When Cool cycle is running, then the snowflake ( ❄️ ) under setpoint should be solid.
- When Heat cycle is running, then the flame ( 🔥 ) under setpoint should be solid.
- When the compressor timer is running before Cool cycle, then the snowflake ( ❄️ ) under setpoint should blink 1.5 seconds **ON** and 0.5 second **OFF**.
- When the compressor timer is running before Heat cycle, then the flame ( 🔥 ) under setpoint should blink 1.5 seconds **ON** and 0.5 second **OFF**.

## Non-programmable Mode

The thermostat is capable of being configured as non-programmable (refer to Configuration Option Number 0140 in Table 7, p. 24). If the thermostat is set to non-programmable mode, certain icons are not displayed and scheduling and override functionality is not available. The Home screens will similarly display as shown below.

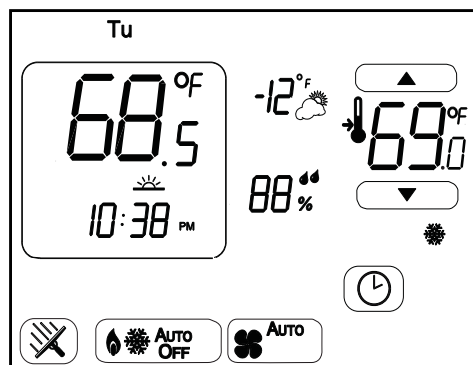

Example of Non-programmable Mode Home Screen:  
Auto Heat/Cool With Cool Setpoint

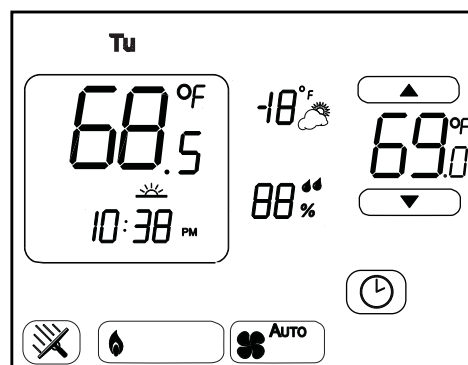

Example of Non-programmable  
Mode Home Screen: Heat Only

### Non-programmable Functionality

- Scheduling and Override modes are not available.
- The following features are not displayed; occupied (🏠), unoccupied (🏠), period schedules (☀️ ☀️ 🌅 🌙).
- Fan can be set to either **AUTO** or **ON**.
- Setpoints are changed directly by touching the setpoint Up/Down arrows. If the system is set to **AUTO**, then the user can toggle between Cool and Heat setpoints with the snowflake icon (❄️) and the flame icon (🔥).
- All other **Non-programmable Mode** functionality is the same as in **Programmable Mode**, such as *System Mode Setup, Fan Mode, Humidity Setup, or Clock*.

## Filter Change

Filter change indicates when the system change filter timer is expired. The filter icon (  ) will blink continuously 1.5 seconds **ON** and 0.5 seconds **OFF** on the **Home** screen (or **TOV Active** screen) until this feature is reset. To reset the filter change indicator, press and hold both left and right arrows at the same time for 3 seconds (refer to the illustration below).

The default setting for filter replacement is one (1) month. To change this duration, refer to Configuration Option Number 0275 in [Table 7, p. 24](#).

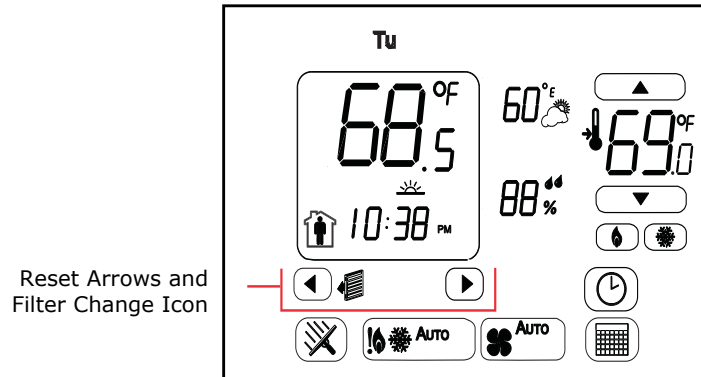

## Clean Screen

The **Clean Screen** feature allows the user to clean the LCD screen by deactivating the touch screen without affecting any current settings. From the **Home** screen, touch the clean screen icon (  ). The LCD screen becomes inactive and only shows a 30-second countdown (shown below on the right) before returning to the **Home** or **TOV Active** screen. Clean the screen with a non-abrasive cloth and a mild ammonia-free cleaning solution.

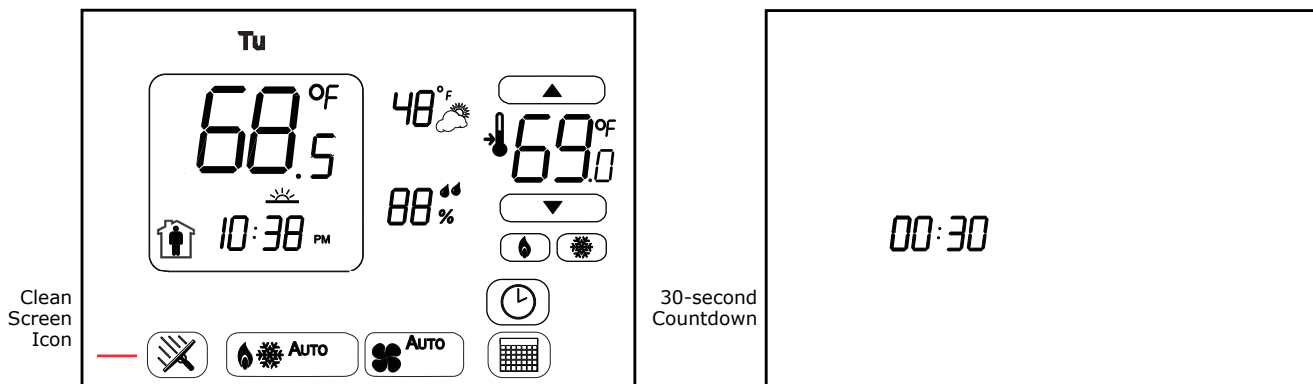

## Local/Remote/Outdoor Temperature Display and Control

The thermostat has the capability of displaying the local indoor temperature and/or the remote indoor/outdoor temperatures, depending on the value setting for Configuration Option Number 0210. There are two terminals to connect the remote sensor, **S1** and **S2**. The table that follows provides information about displaying either local, remote, or outdoor temperatures and how temperatures are controlled (refer to Configuration Option Number 0210 in [Table 7, p. 24](#)).

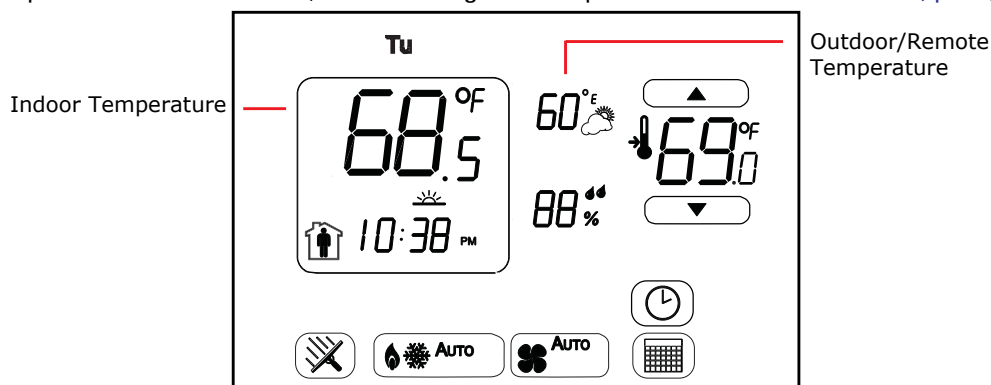

Option Number 0210	Installer Parameter Number Value Description
0	Uses the internal/local sensor for Cool and Heat control. Displays <b>only</b> local indoor temperature.
1	Uses the internal/local sensor for Cool and Heat control. Displays both indoor local and remote temperatures. Remote sensor typically placed outdoors. <sup>(a)</sup>
2	Uses internal/local sensor for Cool and Heat control. Uses remote S1/S2 thermistor for compressor/auxiliary heat lockout feature. Displays both indoor and outdoor temperatures. Remote sensor is typically placed outdoors near compressor equipment. <sup>(a)</sup> (See Option numbers 0220/0221 and the section, "Compressor and Auxiliary Heat Lockout," p. 47, for more details.)
3	Uses S1/S2 thermistor for Cool and Heat control. The internal thermistor is disabled. Displays <b>only</b> the remote indoor temperature and is displayed in the location normally reserved for the local thermistor. Remote sensor is typically placed indoors where H/C control is desired. <sup>(a)</sup>
4	Uses the average temperature of the local sensor and the remote S1/S2 sensor for Cool and Heat control. No secondary temperature displayed. If either temperature is outside the measuring range, an error code will display. <sup>(b)</sup> The average temperature is displayed in the location normally reserved for the local thermistor. Remote sensor is typically placed indoors away from the thermostat to allow temperature averaging from one side of a room to the other. <sup>(a)</sup>

(a) Remote sensor can be placed indoor or outdoor depending on the application.

(b) If an out-of-range error occurs on either the local or remote thermistor (**but not both**), then the firmware will use the good thermistor reading without averaging to control Cool or Heat cycles. If or when the bad thermistor returns to a good state, then the firmware will return to using both thermistors and average the two values.

## Local/Remote Humidity Display and Control

The thermostat has the capability of displaying the local/remote humidity readings, depending on the value setting for Configuration Option Number 0200. An external humidity sensor is connected to terminal **Hp(+)** and **Hs(-)**. The table that follows provides information about humidity sensor selection. For details about setting or changing dehumidification, refer to the section, “Dehumidify Setup,” p. 28.

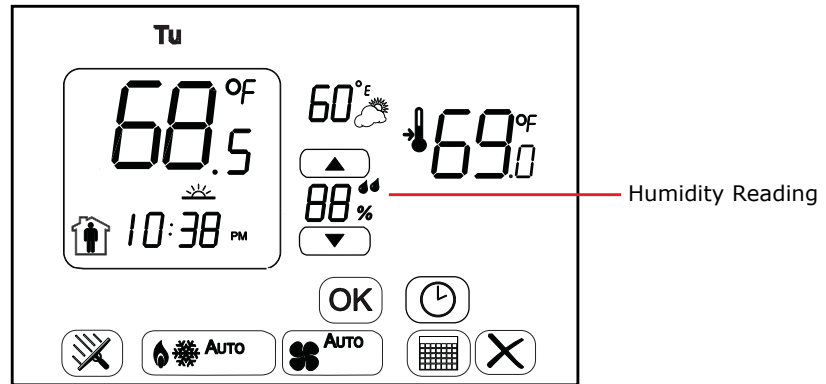

Option Number 0200	Installer Parameter Number Value Description
<b>General Information:</b> For external humidity control, a 4–20 mA humidity sensor must be connected to the Hp and HS terminals. Terminal Hp provides a 24 Vdc nominal to the external humidity sensor. Refer to Table 9, p. 41 below.	
0	No humidity display.
1	Internal humidity sensor is used for control: <sup>(a)</sup> <ul style="list-style-type: none"> <li>0% to 4% and 96% to 99% humidity; blinks the humidity reading and equipment runs for the 96% to 99%.</li> <li>100% humidity; blinks 99 for humidity reading, blinks error code <b>E1</b>, and dehumidify equipment is <b>ON</b>.</li> <li>Communication down or invalid; blinks "--", blinks error code <b>E1</b>, and dehumidify equipment is <b>OFF</b>.</li> </ul>
2	External humidity sensor is enabled: <sup>(a)</sup> <ul style="list-style-type: none"> <li>96% to 99%; blinks humidity reading and dehumidify function is <b>ON</b> because of setpoint.</li> <li>100%; blinks 99% for humidity reading and blinks error code <b>E1</b>. The dehumidify equipment is <b>ON</b>.</li> <li>0% to 4%; blinks humidity reading dehumidify functions is <b>OFF</b> because of setpoint.</li> <li>Current less than 4 mA; blinks "--", blinks error code <b>E1</b>, and dehumidify equipment is <b>OFF</b>.</li> </ul>
<b>Other related Option Numbers</b>	
<b>0205; Dehumidification Control</b>	
0	Active control. The thermostat will toggle the Dh output terminal <b>ON</b> if humidity sensor value is 5% above setpoint and toggle <b>OFF</b> when the humidity sensor value drop 5% below setpoint.
1	Passive control. The thermostat will run cool mode for up to 1 extra minute whenever there is a call for cooling and a call for dehumidification.
<b>0206; Internal Humidity Offset Adjustment:</b> Allows adjustment of the internal relative humidity reading to account for accuracy, tolerance, and potential drift. Firmware uses the adjusted value for display and humidity control.	
-9% to 9% in 1% increments.	
<b>0207; External Humidity Offset Adjustment:</b> Allows adjustment of the external relative humidity reading to account for accuracy, tolerance, and potential drift. Firmware uses the adjusted value for display and humidity control.	
-9% to 9% in 1% increments.	

(a) Blink rate for humidity display 0% to 4%, 96% to 100%, and "--" is 1.5 seconds **ON** and 0.5 seconds **OFF**. Blink rate for error code **E1** is 3 seconds *Error code display* and 1 second *Time Display*.



**Table 9. Remote humidity sensor: Current/voltage versus humidity**

Current (mA)	Voltage	Relative Humidity	Range % (±)
4	1	(Estimated) 0	—
4.8	1.2	(Estimated) 5	—
5.6	1.4	10	0.5
7.2	1.8	20	0.5
8	2	(Low Calibration Point) 25	0.5
10.4	2.6	40	1.0
12	3	50	1.0
16	4	(High Calibration Point) 75	1.5
18.4	4.6	90	1.5
19.2	4.8	(Estimated) 95	—
20	5	(Estimated) 100	—

## System Lockout

The thermostat can be locked out to prevent unauthorized personnel from changing settings. A lockout will disable changes to the following modes: System, Fan, Scheduling, Time, and TOV. If a change attempt is made, the lock icon (🔒) will blink (1 Hz, 20/80%) for 10 seconds on the LCD display and then go solid again.

### To lock the thermostat:

- Simultaneously touch and hold both setpoint increment/decrement arrows for 4 seconds as shown below. When the mode is locked, the lock icon (🔒) blinks (1 Hz, 20/80%) for 5 seconds and then goes solid.

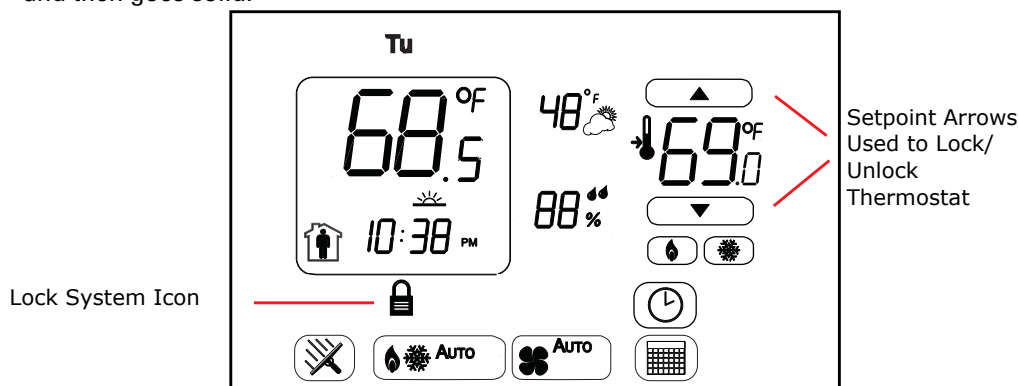

### To unlock the thermostat:

- Simultaneously touch and hold both increment/decrement arrows for 4 seconds. When the mode is unlocked, the lock icon (🔒) will disappear.



# Temperature Cycle Control

The heat and cool cycling rate, expressed in cycles per hour (CPH), indicates how often heating or cooling system is turned on when temperature is within the temperature differential from the setpoint (which is 1°F [0.5°C]). There are ten options (1–10) for heat stages and five options (1–5) for cool stages. The number selected is the maximum number of times the stage is cycled in 1 hour.

For example, when the system is set to 5 CPH, it runs at 12-minute cycles with variable duty cycle. Depending on the heating or cooling load, which is measured by feedback from the sensor thermistor and/or temperature error, the system could run at 50% duty cycle (6 minutes **ON** and 6 minutes **OFF**), 80% duty cycle (9.6 minutes **ON** and 2.4 minutes **OFF**), or other variations of the duty cycle.

**Note:** The cycling rate described above is active only when the temperature is within the temperature differential. If the temperature is outside of the temperature, the heating and cooling equipment will either be fully **ON** or fully **OFF** accordingly.

The following figures show cycling control and includes general notes, if applicable, about each type of cool or heat system.



**Important:** There is a built-in compressor protection delay. The delay guarantees a minimum of 5 minutes between compressor cycling ON/OFF. This built-in delay is added to a configurable additional delay of 0 to 5 minutes as setup in Option Number 0182. The minimum delay will be between 5 and 10 minutes.

Figure 20. Heat only or cool only systems

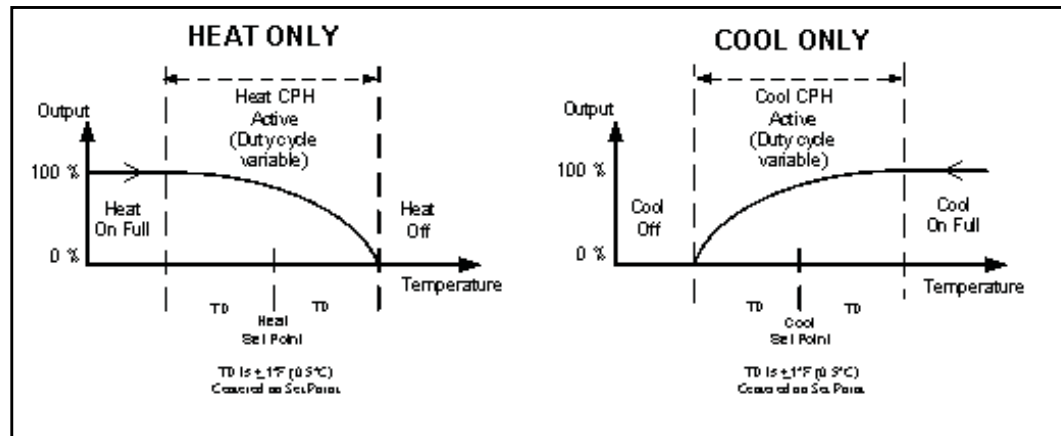

**Figure 21. Auto heat and cool systems**

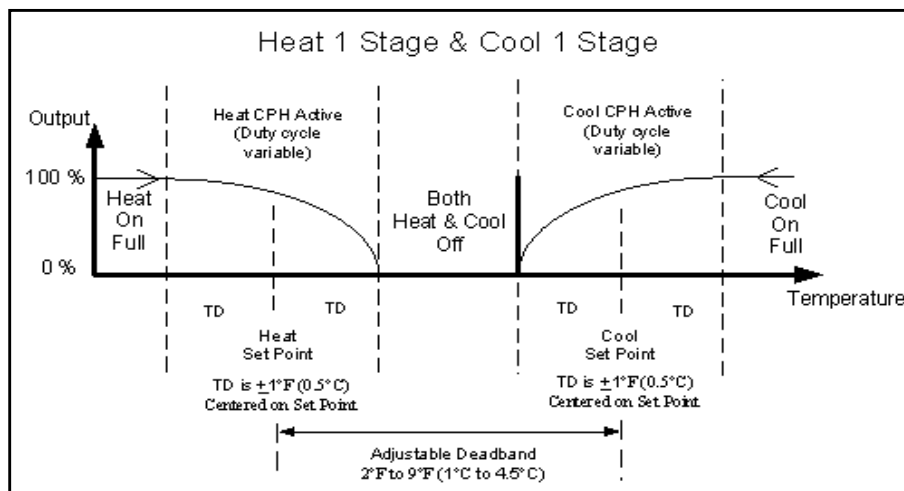

**General Notes:**

- The number of cooling or heating cycles are fixed according to CPH setting value.
- The duty cycle is varied during the cycling control.
- There are five (5) options for cooling CPH selection and ten (10) options for heating CPH selection.
- The cycles per hour for first-stage compressor (Option Number 0160) is used for the first stage of heat pump systems or the first cool stage of conventional systems.

**Figure 22. Auto 2/heat and 2/cool systems**

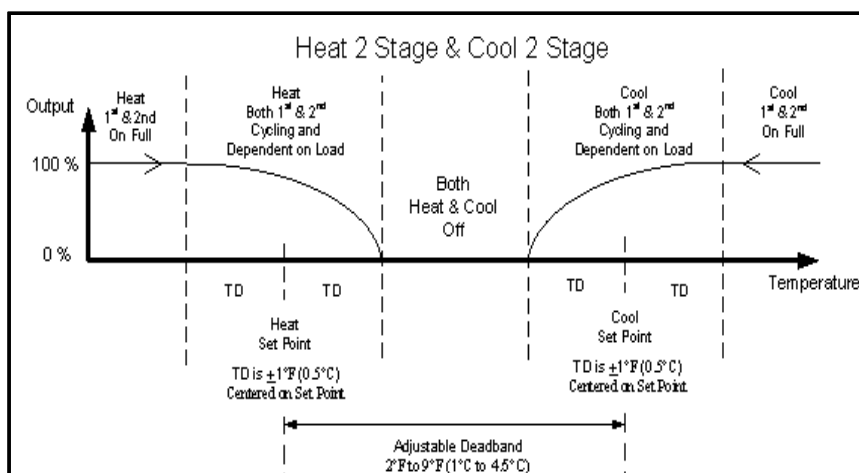

**General Notes:**

- The second-stage output increases the speed of cooling and heating.
- The algorithm of cycling control is the same as the first-stage output. However, the second-stage output has independent cycle period setting.
- All stages used the same temperature differential around setpoint for cycling control.
- When the system is set for 2H/1C HP, the cycles for auxiliary heat (Option Number 0164) is used for the second auxiliary heat stage.

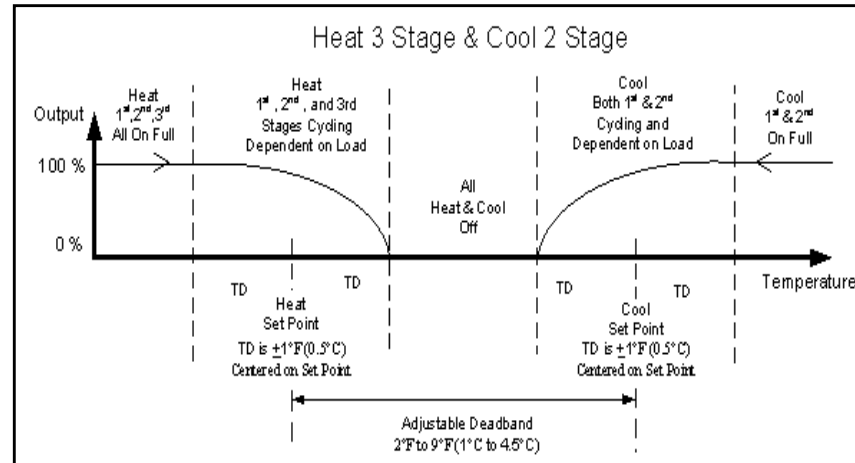
**Figure 23. Auto 3/heat and 2/cool systems**

**General Notes:**

- The third auxiliary-stage heat output is only used for 3H/2C heat pump systems.
- The algorithm of cycling control is the same as the first-stage output. However, it has independent cycle period setting.
- Both the first and second stage use the same temperature differential around setpoint for cycling control.
- When the system is set for 3H/2C HP, the cycles for auxiliary heat (Option Number 0164) is used for the third auxiliary heat stage.

## Other Functional Components

This section provides additional information for understanding thermostat operation or programming. Some of the following sections refer to specific Option Numbers that are listed in [Table 7, p. 24](#).

### Sleep Mode

Sleep mode places the CPU into a *low power* state when the thermostat is inactive.

**Note:** *Sleep mode is not implemented, but is noted here for future reference.*

### Changeover Operation

When the system is set to **AUTO Mode**, the thermostat automatically selects **Cool Mode** or **Heat Mode** depending on the room temperature and the setpoint temperature. If the changeover setting is set to manual, then **AUTO Mode** cannot be selected when selecting system type and the user would need to manually change between Cool and Heat Modes. (Refer to 0180)

### Changeover Valve Control

The changeover valve control (reversing valve O/B) is used only with heat pump systems. Configuration Option Number 0153 determines whether the O/B signal is active for cooling or heating (default is O/B active for cooling).

## Extension of Fan-on Time

The system fan-on time is able to be extended for either or both cooling or heating mode. For cooling, the extension time is 90 seconds and for heating it is 40 seconds (refer to 0270 and 0271).

## Economizer/Time of Day (TOD)

You can set the Economizer or TOD mode using Option Number #150 to one of two settings:

- **Economizer Mode** - Terminal **A** is energized with the thermostat in Occupied mode, Unoccupied mode with a call for cool, or a Temporary Override mode (TOV) active.
- **TOD Mode** - Terminal **A** is energized with thermostat in Occupied mode or a Temporary Override mode (TOV) active.

**Note:** *TOD is **not** available in non-programming mode.*

The table below summarizes the bulleted statements.

**Table 10. Operation summary**

Occupancy	Call for Cool	Terminal A (Programmable Mode)		Terminal A (Non-programmable Mode)	
		Economizer	TOD	Economizer	TOD
Occupied	Don't Care	Energized	Energized	NA	NA
Unoccupied	YES	Energized	De-energized	Energized	NA
Unoccupied	NO	De-energized	De-energized	De-energized	NA
Temporary Override	Don't Care	Energized	Energized	NA	NA

## Configuration, Time, and Programming Retention

The thermostat retains the time and date for a minimum of 5 days of loss power. If power is lost for more than 5 days, the time and date will need to be restored when power is returned. All configuration settings, system settings, and scheduling are stored in non-volatile memory which will retain the data indefinitely with/without power

**Note:** *The user can manually reset the thermostat to all default settings by changing Configuration Option Number 0300 to 1.*

## Heat/Cool Relay Confirmation

As a guard against inadvertent relay switching, the thermostat firmware will set/reset the output relays every half hour if the relationship of setpoint versus temperature is out of range as follows:

- Auto systems with cool/heat setpoints: temperature is 5°F (2.5°C) above the cool setpoint or 5°F (2.5°C) below the heat setpoint
- Only heat systems: temperature is above or below the heat setpoint by 5°F (2.5°C)
- Only cool systems: temperature is above or below the cool setpoint by 5°F (2.5°C)

## Deadband

The thermostat automatically maintains a temperature deadband between the heating setpoint and the cooling setpoint whenever the thermostat is configured for heat and cool— this applies to Auto or manual H/C setup. The temperature range of the deadband is 2°F to 9°F (1.0°C to 4.5°C) and is specified in the installation Configuration Option 0181 (see ["Configuration Option Setup," p. 23](#)). If attempting to change a temperature setpoint to within the deadband of its opposing setpoint, the opposing setpoint will automatically be pushed to the next value that satisfies the deadband.

## Temperature Display Offset

The offset parameter applies *only* to the **Local Temperature Display** (when Configuration Option Number 0210 is set to 0, 1, or 2) or to the **Indoor Remote Temperature Display** (when Configuration Option Number 0210 is set to 3). It *does not* apply to the **Outdoor Remote Temperature Display** (when Configuration Option Number 0210 is set to either 1 or 2). The offset range is -3°F to 3°F (-1.5°C to 1.5°C) [Refer to 0210 and 0260]. When Configuration Option Number 0210 is set to 4, the offset will apply after the average temperature is calculated from both the internal and remote temperature sensor. If one sensor goes bad, then the offset will apply to the remaining good temperature sensor reading.

## Humidity Display Offset

Humidity offset allows adjustment of the humidity reading in the field. The offset range is -9% to 9%. There is a separate humidity offset for the internal and external humidity sensor. (Refer to 0206, 0207)

## LCD Backlight

With Configuration Option Number 0170 set to 0 for Non-continuous Backlight, the backlight will turn **ON** if any touch areas of the display screen are touched and turn **OFF** after a timer expires.

**Note:** *When Configuration Option Number 0170 is set to 1, the backlight is **ON** continuously with no time outs.*

Typical expiration times are:

- 15 seconds from **Home** screen non-functional area touches (typically 20 seconds for a functional area touch plus an extra 15 seconds after returning to **Home** or **TOV Active** screens).
- 60 seconds when in **Schedule Change Mode**, plus an extra 15 seconds after exiting.
- 30 seconds in **Clean Screen Mode** plus an extra 15 seconds after returning to **Home** or **TOV Active** screens.
- Backlight on during Power Up sequence plus an extra 15 seconds after arriving at the **Home** screen.
- **ON** continuously in **Configuration and Test Modes**.

## Compressor Protection

Compressor protection prevents damage to the compressor of either an air conditioning or heat pump system. Damage could occur if the compressor is restarted too soon after shutdown. This feature causes the compressor to delay between 0 to 10 minutes, depending on previous state of compressor (**ON** or **OFF**), and Configuration Option Number 0182.

**Note:** *The Heat/Cool algorithm will add anywhere from 0 to 5 minutes and Configuration Option Number 0182 can add an additional 0 to 5 minutes, depending on the setting.*

A time delay is activated after the compressor turns **OFF**. During the delay (when there is a call for cool or heat pump heat), either Cool/ Heat indicator icons will blink on the LCD screen for a duration of 1.5 seconds **ON** and 0.5 seconds **OFF**. When this time expires, either **Cool Mode** or **Heat Mode** displays solid on the screen and the compressor turns **ON**.

The delay timer is also activated upon initial startup and after power interruptions.

## Permanent Memory Data

When setting up the thermostat, the schedule and configuration values are stored to permanent memory. These permanent values are restored each time at startup. If a Checksum error occurs in

permanent memory, the factory default preset parameters are used and are stored to permanent memory.

The entire permanent memory data can be reset manually back to factory default data using Configuration Option Number 0300.

**Note:** In instances where there is a loss of two (2) power cycles, the firmware limits the EEPROM write to five (5) writes of data for 24 hours. Thereafter, the EEPROM write capability is disabled. After 24 hours, the counter resets and allows five more 2-cycle power loss EEPROM writes for the next 24 hours.

## Compressor and Auxiliary Heat Lockout

This function is available with only Configuration Option Number 0210 set to 2 and with one or both Configuration Option Numbers 0220 and 0221 set to some other setting except zero (0).

Compressor and auxiliary heat is used for heat pump systems with more heat stages than cool stages. When the temperature from an outdoor sensor is:

- Above the auxiliary lockout point, only the compressor will operate on a call for heat.
- Below the compressor lockout point, only the auxiliary heat will operate on a call for heat.
- Between the compressor and auxiliary lockout points, the compressor and auxiliary heat will operate on a call for heat.

There is a minimum 5°F (2.5°C) deadband between compressor and auxiliary heat lockout temperatures. Configuration option #220 sets the compressor lockout point; #221 sets the auxiliary lockout point. Refer to the following illustrations.

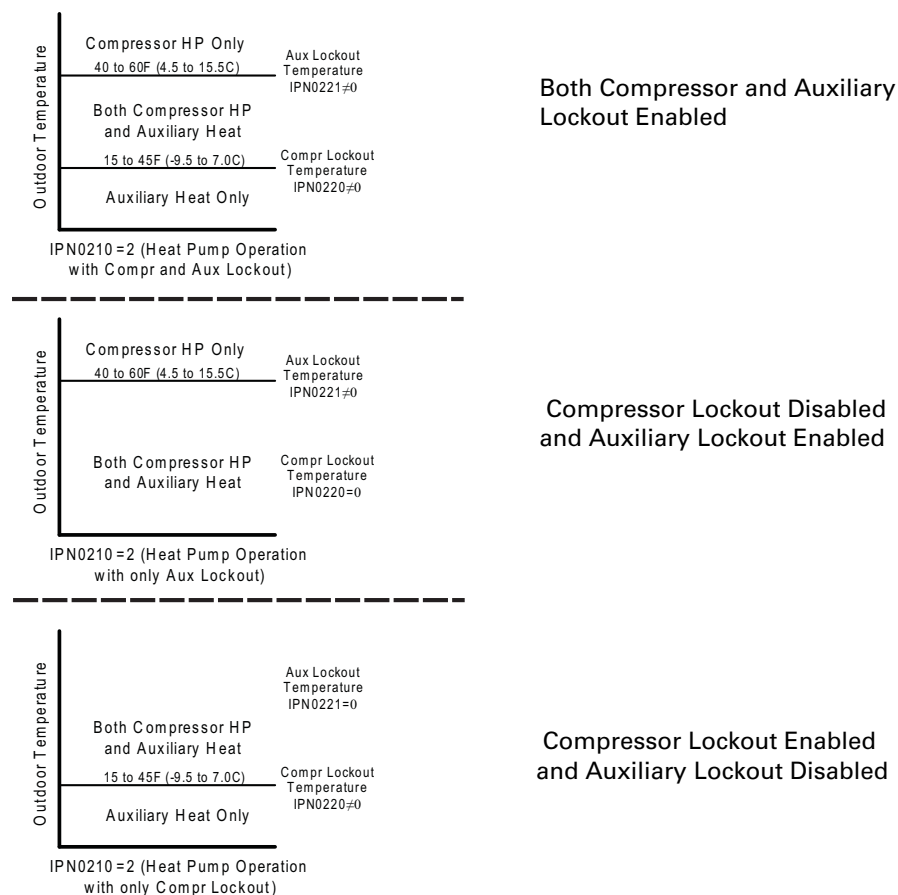



# Error Codes and Exceptions

## Error Codes

Error codes indicate a possible need for technical assistance. Error codes display where the time of day is located. When an error occurs, the error code will blink first (for 3 seconds) and then blink the time of day (for 1 second) and back to the error code in 4-second intervals.

During normal operation, the errors will be displayed in the following priority:

**E4 > E0 > E1 > E3 > E5 > E7**; only the highest priority code will display. If there are multiple error codes, once the first code is cleared, the next code will display according to priority. The following table provides a list of codes and descriptions:

**Table 11. Error codes**

Code	Description of Occurrence
E0; Internal/External Thermistor <i>(Refer to 0210)</i>	<ul style="list-style-type: none"> <li>• <b>0210= 0,1, or 2</b>; Local internal thermistor resistance is less than 714 Ω (209°F [98.3°C]) or greater than 561 kΩ (-53.3°F [-47.5°C])</li> <li>• <b>0210= 3</b>; Remote external thermistor (S1, S2) resistance is less than 714 Ω (209°F [98.3°C]) or greater than 561 kΩ (-53.3°F [-47.5°C])</li> <li>• <b>0210= 4</b>; Either local or remote thermistor resistance is less than 714 Ω (209°F [98.3°C]) or greater than 561 kΩ (-53.3°F [-47.5°C])</li> </ul> <p><b>Note:</b> When the thermistor used for control is out of range, then all Cool/Heat outputs turn <b>OFF</b>. The <b>Fan AUTO</b> mode turns <b>OFF</b> the fan. The <b>Fan ON</b> mode will allow the fan to continue to run.</p> <p><b>Note:</b> For Configuration Option Number 0210= 4 and <b>only</b> one of the thermistors is out of range, the firmware will bypass averaging and only use the thermistor that is within an acceptable range to control Cool and Heat. When both thermistors return to range, the temperature averaging resumes. E0 will flash if either is out of range.</p> <p><b>Note:</b> For settings that use both internal/external thermistors, if the thermistor used for control is in range, then normal operation should continue. However, E0 should flash until the out-of-range thermistor is fixed.</p> <p><b>Note:</b> For resistance &gt;561 Ohms, tolerance is ±7%. For resistance &lt;714 Ohms, tolerance is ±3%.</p>
E1; Internal/External Humidity Sensor <i>(Refer to 0200)</i>	<ul style="list-style-type: none"> <li>• <b>0200= 0</b>; This error check is disabled.</li> <li>• <b>0200= 1</b>; Invalid, no communication, or 100% humidity with internal humidity sensor. "--" displays in the humidity display location for invalid or no communication. "99" will blink in the humidity display location for 100% humidity reading.</li> <li>• <b>0200= 2</b>; Current reading is out of range and is less than 4 mA or greater than 19.94 mA (100% humidity reading). For readings less than 4mA, "--" will blink in the humidity display location. For 100% humidity readings, "99" will blink in the humidity display location.</li> </ul> <p><b>Note:</b> Blink rate for humidity <i>Out of Range</i> or error <i>E1</i> display is 1.5 seconds <b>ON</b> and 0.5 seconds <b>OFF</b>.</p>
E2	Reserved
E3;Permanent Data	Permanent data error. Access error or checksum error is detected.
E4;Input Voltage Out of Range	<ul style="list-style-type: none"> <li>• Input voltage out of range and is either too low or too high.</li> <li>• Operating range is 18 to 32 Vrms.</li> <li>• Low error detection is less than 16.6, ±8.5%.</li> <li>• High error detection is greater than 34, ±8.5%</li> </ul>
E5; Real Time Clock (RTC)	RTC (Real Time Clock) Error.
E6	Reserved
E7; Memory	<ul style="list-style-type: none"> <li>• Memory error (write and read 0x55 and 0xAA failed).</li> <li>• Only checked during power-up test.</li> </ul>



## Exceptions

There are exceptions to be noted when using the thermostat. These exceptions are:

- If the indoor or outdoor temperature is lower or higher than the measuring range, the temperature display will blink either "--F" (Fahrenheit) or "--C" (Celsius) at 1.5 seconds **ON** and 0.5 seconds **OFF**. All other outputs remain functional. Display range is -45°F to 199°F (-42.8°C to 92.8°C)
- If the system fails to access EEPROM for 10 minutes, the system will blink with *E3* (3s= Error Code and 1s= Time Display). However, it will continue to operate at its current mode (refer to the section, "Error Codes," p. 48).
- If any of the above exceptions listed should occur, the temperature control will continue to operate normally and all outputs remain functional.
- The humidity sensor error blinks 1.5 seconds **ON** and 0.5 seconds **OFF** in the humidity reading area and blink Error Code E1 (3s= Error Code and 1s= Time Display). The humidity function will continue to operate for readings 0% to 100% for both internal/external humidity sensors. However, the humidity function will shut down for a communication error with the internal humidity sensor and with less than 4 mA for external humidity sensor.



# Troubleshooting

Use the following table to diagnose and resolve problems.

**Table 12. Troubleshooting**

Problem	Solution
Error code E0 - Thermistor error.	<ul style="list-style-type: none"> <li>For configuration option #210 set to 1, 2, 3, or 4:</li> <li>Check the sensor terminals S1 and S2 for secure connection. If wires are securely connected, try replacing the sensor. If the error persists, have the thermostat serviced or replaced by a qualified Trane supplier.</li> </ul>
Error code E1 or "--" flashing in humidity display	<ul style="list-style-type: none"> <li>Humidity reading is outside of the measurable range or there is an error with the humidity sensor.</li> <li>For internal humidity sensor, try a power cycle to see if the sensor recovers.</li> <li>For external humidity sensor, check Hs and Hp terminals and/or ensure that the remote humidity sensor is not damaged or malfunctioning. Replace if necessary.</li> <li>If there is no recovery, have the thermostat serviced or replaced by a qualified Trane supplier.</li> </ul>
Error code E4 - Input voltage out of range	<ul style="list-style-type: none"> <li>Check the input voltage to the thermostat. It must be within the range of 18 Vac to 32 Vac RMS.</li> </ul>
Error codes E3 or E7	<ul style="list-style-type: none"> <li>Cycle the power to the thermostat.</li> <li>If it does not recover to normal operation, have it serviced or replaced by a qualified Trane supplier.</li> </ul>
Error code E5 - RTC (Real Time Clock)	<ul style="list-style-type: none"> <li>Set the clock from the <b>Home</b> screen.</li> <li>Power cycle the unit.</li> <li>If E5 remains, have the thermostat serviced or replaced by a qualified Trane supplier.</li> </ul>
Blank display	<ul style="list-style-type: none"> <li>Check the power supply.</li> <li>If the power supply is ok, have the thermostat serviced or replaced by a qualified Trane supplier.</li> </ul>
Icons display missing or only partially showing	<ul style="list-style-type: none"> <li>Run Test #7 (refer to the section, "System Tests," p. 20) to view odd, even, and full icon segment display.</li> <li>Power cycle the thermostat.</li> <li>If problem persists, have the thermostat serviced or replaced by a qualified Trane supplier.</li> </ul>
Erratic display appearance or contrast	<ul style="list-style-type: none"> <li>Check the power supply (24 Vac nominal) and frequency setting (Configuration Option Number 0170).</li> <li>Cycle the power to the thermostat.</li> <li>After verifying the power supply and frequency setting, have the thermostat serviced or replaced by a qualified Trane supplier.</li> </ul>
Display screen does not respond	<ul style="list-style-type: none"> <li>Make sure the thermostat modes are not locked (refer to the section, "System Lockout," p. 41).</li> <li>Cycle the power to the thermostat.</li> <li>Run Test #8 to confirm touch response.</li> <li>If the screen is not locked and cycling the power do not solve the problem, have the thermostat serviced or replaced by a qualified Trane supplier.</li> </ul>
--F" or "--C" flashes	<ul style="list-style-type: none"> <li>Temperature is outside of the measurable range. The temperature display should return when the temperature is within the measurable range.</li> <li>For Remote Temperature Reading; if temperature is within measurable range (refer to Table 11, p. 48) then check/replace the remote temperature sensor.</li> <li>For Local Temperature Reading; if temperature is within measurable range, then have the thermostat serviced or replaced by a qualified Trane supplier.</li> </ul>
Fan settings are not visible	<ul style="list-style-type: none"> <li>Check the system status. If the system is <b>OFF</b>, the fan settings will not appear.</li> <li>Check the Configuration Option Numbers 0130 and 0151 to verify that the fan is enabled.</li> </ul>
Relays do not turn ON	<ul style="list-style-type: none"> <li>Go to Test Modes 1–6 (refer to the section, "System Tests," p. 20) to toggle the relay(s) in question. If the relay(s) do not toggle in test mode, then have the thermostat serviced or replaced by a qualified Trane supplier.</li> </ul>





Trane optimizes the performance of homes and buildings around the world. A business of Ingersoll Rand, the leader in creating and sustaining safe, comfortable and energy efficient environments, Trane offers a broad portfolio of advanced controls and HVAC systems, comprehensive building services, and parts. For more information, visit [www.Trane.com](http://www.Trane.com).

Trane has a policy of continuous product and product data improvement and reserves the right to change design and specifications without notice.

© 2011 Trane. All rights reserved.

BAS-SVX44A-EN 28 July 2011

NEW

