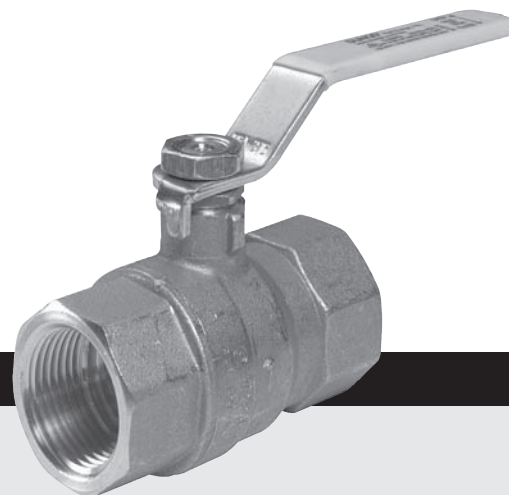

**Table of Contents**

Table of Contents ..... Page 1  
 Approvals ..... Page 1  
 Attention ..... Page 1  
 Specification ..... Page 2  
 Locking Devices ..... Page 2  
 Mounting ..... Page 3  
 Attention: Mounting Handle on Side ..... Page 3  
 Never Remove Lever ..... Page 3



**Approvals**



UL Listed:  
File # MH18741



CSA Certified:  
File # 209183



FM Approved:  
File # 1B7A5.AH

Commonwealth of Massachusetts Approved Product Approval code G1-1107-35

**Attention**



The installation and maintenance of this product must be done under the supervision of an experienced and trained specialist. Never perform work if gas pressure or power is applied, or in the presence of an open flame.



On completion of installation on the ball valve, perform a leakage and function test.



Please read the instruction before installing or operating. Keep the instruction in a safe place. You find the instruction also at [www.dungs.com](http://www.dungs.com) If these instructions are not heeded, the result may be personal injury or damage to property.



This product is intended for installations covered by, but not limited to, the following codes and standards: NFPA 86, CSD-1, ANSI Z21.13, UL 795, NFPA 85, CSA B149.3, NFPA 37 and CSA B149.1.



Any adjustment and application-specific adjustment values must be made in accordance with the equipment manufacturers instructions.

**Explanation of symbols**

- 1, 2, 3 ... = Action
- = Instruction

## Specification

**KH** Manually operated ball valve for gas piping carrying natural gas, propane, butane, air and inert gases.

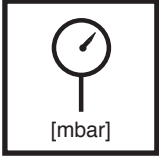

**Factory Rated Max. Operating Pressure**  
125 PSI (4225 mbar)

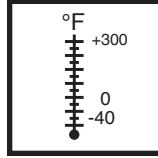

**Ambient / Medium Temperature**  
-40 °F ... +300 °F  
(-40 °C ... +150 °C)

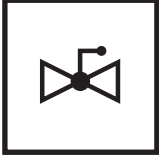

**Classification of Valve for up to 2" NPT**  
UL 125 Subject 258 (125 PSI)  
ANSI Z21.15; CSA 9.1 (0.5 PSI)  
ANSI B16.33; CSA 3.16 (125 PSI)  
CSA 3-88 and CGA CR91-002 (125 PSI)  
ASME 16.44 (5 PSI)

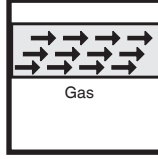

**Gases**  
Natural gas, propane, butane & other noncorrosive gases  
**Materials in contact with Gas**  
Housing: Forged brass  
Seals: PTFE O-rings; Viton

Body size	Size	Order No.
KH 01/6-02	1/4" NPT	D240-887
KH 01/6-03	3/8" NPT	D240-889
KH 01/6-05	1/2" NPT	D240-890
KH 01/6-07	3/4" NPT	D240-891
KH 01/6-10	1" NPT	D240-892
KH 01/6-12	1 1/4" NPT	D240-893
KH 01/6-15	1 1/2" NPT	D240-894
KH 01/6-20	2" NPT	D240-895
KH 01/6-25	2 1/2" NPT	D240-896
KH 01/6-30	3" NPT	D240-897

## Locking Devices

Locking devices are available for the KH series ball valves from 1/2" NT up to 2" NPT.

Description	Order No.
1/2" to 3/4"	48650-11
1" to 1 1/4"	48650-31
1 1/2" to 2"	48650-41

## Mounting

### Installation Position

Safety shutoff valve from vertically upright to horizontal.

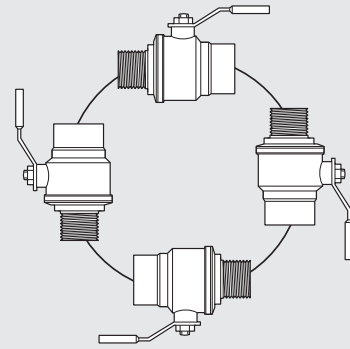

### Recommended Piping Procedure

1. Examine the valve for shipping damage.
2. The main gas supply must be shut off before installation.
3. The inside of the valve, threads and piping all must be clean and free of dirt and debris. Failure to remove dirt/debris could result in valve damage or cause improper performance.
4. Use new, properly reamed and threaded pipe free of chips.
5. Apply good quality pipe sealant, putting a moderate amount on the male threads only. If pipe sealant lodges on the valve seat, it will prevent proper operation. If using LP gas, use pipe sealant rated for use with LP gas.
6. Do not thread pipe too far. Valve distortion and/or malfunction may result from excess pipe in the valve body.

7. Apply counter pressure only a parallel jaw wrench only to the flats on the flange when screwing the pipe into the flanges.
8. Do not overtighten the pipe. Follow the maximum torque values listed below.
9. After installation is complete, perform a leak test.

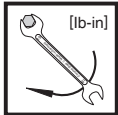
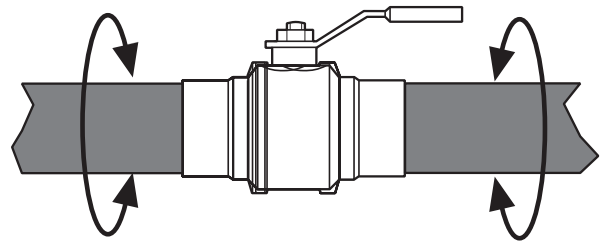

Recommended Torque for Piping	1/2"	3/4"	1"	1 1/4"	1 1/2"	2"	2 1/2"	3"	NPT pipe
		443	752	1106	1770	1991	2213	2876	3540

### Attention: Mounting Handle on Side

If the ball valve is mounted so that the handle is on the side, as shown to the right, the handle must close the ball valve when actuated downwards as illustrated to the right.

**!** When installing a new ball valve 1" and larger, there is a large amount of torque require to actuate the ball valve first time because of the lack of lubrication on the ball itself. In order to actuate the valve, mount into a vice or on a gas train and turn the handle. Once actuated, the valve is now lubricated and easier to turn.

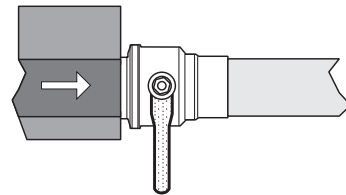
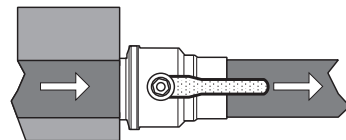

### Never Remove Lever

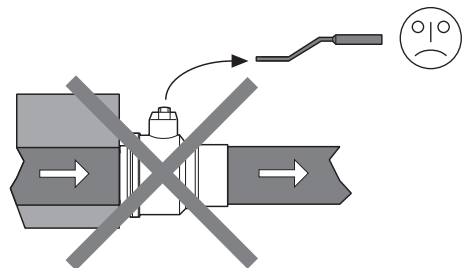
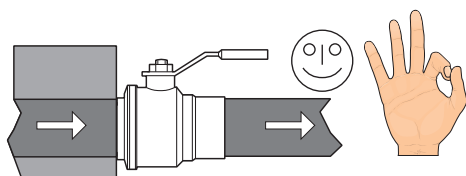

**!** Never permanently remove the handle from the ball valve.

We reserve the right to make modifications in the course of technical development.



**Karl Dungs Inc.**  
3890 Pheasant Ridge Drive NE  
Suite 150  
Blaine, MN 55449, U.S.A.  
Phone 763 582-1700  
Fax 763 582-1799  
e-mail [info@karldungsusa.com](mailto:info@karldungsusa.com)  
Internet <http://www.dungs.com/usa/>

**Karl Dungs GmbH & Co. KG**  
P.O. Box 12 29  
D-73602 Schorndorf, Germany  
Phone +49 (0)7181-804-0  
Fax +49 (0)7181-804-166  
e-mail [info@dungs.com](mailto:info@dungs.com)  
Internet <http://www.dungs.com>