



**WARNING LABEL  
PART NO. V56871  
INSTALLED IN  
THIS LOCATION.  
IF MISSING, IT  
MUST BE REPLACED.**



**WARNING TAG  
V56878 INSTALLED  
IN THIS LOCATION.  
IF MISSING, IT  
MUST BE REPLACED.**

# Dual Unit Valves

## Installation, Operation & Service Instructions

**WARNING:** Dangerous over pressure conditions may cause boiler to explode. This relief valve **MUST NOT** be used instead of a safety relief valve that meets the requirements of the ASME Code. Failure to follow these instructions could result in serious personal injury or death and property damage.

**INSTALLER: PLEASE LEAVE THIS MANUAL FOR THE OWNER'S USE.**



### SAFETY INSTRUCTIONS

This safety alert symbol will be used in this manual to draw attention to safety related instructions. When used, the safety alert symbol means ATTENTION! BECOME ALERT! YOUR SAFETY IS INVOLVED! FAILURE TO FOLLOW THESE INSTRUCTIONS MAY RESULT IN A SAFETY HAZARD.

**NOTE:** Bell & Gossett does not recommend Dual Unit Valves to be used for potable water.

### PRESSURE SETTING

Relief Valve: 30 PSI Standard  
Reducing Valve: 12 PSI Standard, 10 to 25 PSI Adjustable Range.  
Maximum Operating Temperature: 225 °F.  
Maximum Working Pressure: 125 PSIG.  
Maximum Flow: 5 1/2-6 GPM at 125 PSIG Inlet Pressure.

### DESCRIPTION

B&G Dual Unit Valves are a combination of a pressure reducing valve and a relief valve. The Dual Unit Valve is designed for filling hot water boilers and associated piping systems to a properly controlled pressure after boiler installation or system servicing. It is not a safety device and is not intended to be used as a water feed valve to control boiler water at a safe operating level or pressure. Both valves are factory set, although the reducing valve portion may be field adjusted. Dual Unit Valves are equipped with a built-in-strainer and low inlet pressure check valve.

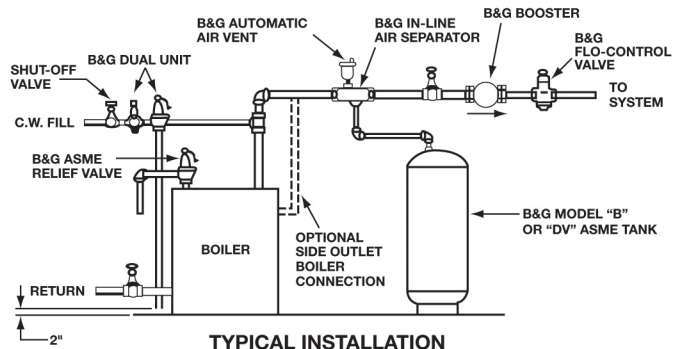

MODEL NO.	COMPONENT VALVES	BODY MATERIAL	CONNECTIONS INCHES		DIMENSIONS INCHES		APPROX. SHP. WT. LBS. EA.
			BOILER	FILL	BETWEEN CONNECTION	OVERALL HEIGHT	
8	RELIEF	BRASS	1/2 NPT	1/2 NPT	6 7/16	5 3/8	4
	B-38						
F-3*	RELIEF	BRASS	1/2 NPT	1/2 NPT	6 7/16	6	3 3/4
	B-38						
F-3TU*	RELIEF	BRASS	1/2 UNION NPT SWEAT	1/2 UNION NPT SWEAT	8 5/8	6	4
	B-38TU						



**WARNING:** State of California Residents, this product contains a chemical known by the State of California to cause cancer. This product contains a chemical known by the State of California to cause birth defects or other reproductive harm.

**\*NOTE:** Fast-Fill models must be installed in upright position (i.e. flow arrow along horizontal axis).

## INSTALLATION INSTRUCTIONS

The Dual Unit Valve must be installed with the flow arrow on the reducing valve body pointing in the direction of flow. A shutoff valve must be installed on the city water side of the Dual Unit Valve. If the pressure reducing valve portion of the Dual Unit Valve is not equipped with a fast fill feature, a bypass may be used for rapid system fill, but it must remain closed during normal system operation.

For safe boiler operation, installation of a low water cut off, adequate burner safety controls, and a properly installed float operated water feed control is recommended. Examples of these types of control devices include the McDonnell & Miller No. RB-24 and RB-120 low water cut off and the No. 47-2 combination feeder and low water cut off. Uncontrolled firing and overheating of boiler and boiler components may occur in a hot water heating system that is installed without adequate safety controls. The installation of a functioning air control system and thermal compensation system is required for the proper operation of a hot water heating system.

 **WARNING:** Injecting cold water into a boiler that has overheated due to uncontrolled firing and/or improper water level control can cause excessive stresses in boiler components and possible rupture of the boiler. This will be prevented by proper selection and installation of a water level control and burner safety controls. The shut off valve at the Dual Unit Valve inlet must be closed except when filling the system, after installation, or after service. Failure to follow these instructions could result in serious personal injury or death and property damage.

1. Pipe the Dual Unit Valve into the system as shown on the typical installation drawing on page 1.

 **CAUTION:** The generous use of pipe joint compound when installing a Dual Unit Valve will foul the valve operating mechanism, preventing it from functioning properly. Pipe joint compound must be conservatively applied to male threads only. Failure to follow these instructions can result in moderate personal injury or property damage.

 **CAUTION:** The use of PTFE impregnated pipe compound and PTFE on pipe threads provides lubricity which can lead to overtightening and breakage. Do not overtighten. Failure to follow these instructions can result in moderate personal injury from hot water and/or property damage.

2. Never reduce the inlet, outlet or drain connections to the Dual Unit Valve.
3. When installing Dual Unit Valve models that include a sweat union connection feature, first sweat the tailpiece in place, then assemble the union nut to the Dual Unit Valve.

 **WARNING:** The use of improper procedures to sweat Dual Unit Valve models with union connection into a system can damage the Dual Unit Valve. Before installing sweat union connection to Dual Unit Valve, the union connection must be first sweated (soldered) into place. Failure to follow these instructions could result in serious personal injury or death and property damage.

4. Do not install shutoff valves between the Dual Unit Valve and the heating system.

5. Do not install shutoff valves in the drain piping from the relief valve portion of the Dual Unit Valve.
6. Terminate the Dual Unit Valve drain line approximately 2" above the floor or floor drain, so that any discharge is visible. This is necessary to minimize the possibility of scalding someone who may be standing nearby if the relief valve portion of the Dual Unit Valve discharges.
7. A shutoff valve must be installed in the cold water supply line ahead of the Dual Unit Valve. This valve must be kept closed except when filling the system.

## OPERATION INSTRUCTIONS

Open the cold water shut off valve. The system will fill until the 12 psig preset pressure of the Dual Unit Valve has been achieved.

Models F-3 and F-3TU are equipped with a fast fill lever. When filling the system, place the fast fill lever in the top vertical position. THIS OVERRIDES THE PRESSURE REGULATION FUNCTION OF THE DUAL UNIT REDUCING VALVE. Fill the system until the boiler pressure gauge indicates the preset pressure of the Dual Unit Valve. Then place the fast fill lever in the horizontal position for normal automatic operation.

 **WARNING:** Improper use of fast fill features can result in over pressurization of the boiler system. The fast fill lever must never be left in the upright position after the system has been filled. The handle must be placed in the horizontal position to avoid over pressurization and unnecessary relief valve discharge. Damage to the Dual Unit Valve and other system components can result. Failure to follow these instructions could result in serious personal injury or death and property damage.

 **WARNING:** Low pressure conditions may occur during uncontrolled overfiring of the boiler. This could result in cold water being added to an extremely overheated boiler, causing excessive stress on boiler components and possible rupture of the boiler. The shut off valve, installed on the Dual Unit Valve inlet, must be kept closed except during initial system fill, or when manually adding water to the system because of a loss of pressure. This will prevent water from being added to an overheated boiler. **NEVER ADD WATER TO AN OVERHEATED BOILER.** Failure to follow these instructions could result in serious personal injury or death and property damage.

 **CAUTION:** Corrosion and eventual failure of system components can result from the constant addition of fresh water. After the system has been filled, the cold water shut off valve must be closed. This will prevent system leaks from being undetected by the constant replacement of lost system water. Failure to follow these instructions could result in property damage and/or moderate personal injury.

## PRESSURE SETTING

The pressure setting of the Dual Unit Valve's pressure reducing valve can be changed by the following steps:

1. Allow water in heating system to cool to below 100°F.

- Adjust the reducing valve pressure setting by loosening the jam nut on top of the reducing valve and turning the slotted adjusting screw. Turn the screw clockwise to increase the set pressure, or counterclockwise to lower the set pressure. Adjust slowly until the boiler pressure gauge indicates the desired fill pressure.

**NOTE:** Do not adjust the pressure to less than 10 psi.

- Hold the adjusting screw stationary with a screwdriver and tighten the jam nut.
- Return the system to normal operation.

#### NOTE ON RELIEF VALVE OPERATION

The Dual Unit relief valve does not operate unless there is an over pressure condition. If the relief valve discharges periodically, it is an indication that the compression or expansion tank may have lost its air cushion. To determine if this is the case, initiate the following test:

- Bladder or diaphragm style pre-charged tanks:** Shut off boiler and allow system to cool to below 100°F. Isolate the tank from the system, then bleed the water from the tank. Place a tire-type pressure gauge on the air valve on the tank. If the pressure is zero, the air cushion is lost. The absence of the air cushion may be from a leaking air valve. To check if this is the case, add some air to the tank and place some liquid on the valve stem area. If the liquid bubbles, the valve is leaking and must be replaced (see Instruction Manual A01500 for valve replacement). If the absence of the air cushion was not caused by a leaking valve, then the bladder or diaphragm is leaking, and the bladder must either be replaced (for the “B” Series) or the tank must be replaced (for the “D” Series). See Instruction Manual A01500 for bladder replacement.
- Conventional compression tanks:** Shut off the boiler for approximately 30 minutes. Record the pressure. Turn the boiler on. If, within 8-9 minutes, the pressure gauge at the boiler indicates a value within 10% of the relief valve setting, then the tank is waterlogged and needs to be drained and recharged (see Instruction Manual S10300 for drain and aircharge procedures).

**WARNING:** Frequent discharging of the relief valve will cause scale to build up in relief valve, preventing it from relieving pressure above its set point. Correct cause of frequent over pressurization. Failure to follow these instructions could result in serious personal injury or death and property damage.

The relief valve pressure setting is factory set, is not field adjustable, and must not be tampered with.

**WARNING:** Changing relief valve setting can cause an explosion. Do not attempt to change relief valve setting. Failure to follow these instructions could result in serious personal injury or death and property damage.

## SERVICE INSTRUCTIONS

### DUAL UNIT REDUCING VALVE

If the pressure reducing valve fails to maintain the set *COLD* fill pressure, the strainer may be clogged. To service the strainer follow these steps:

- Shut off the city water or cold water shutoff valve.
- Turn the boiler on-off switch to the “OFF” position.

**WARNING:** System fluid under pressure and/or at high temperature can be very hazardous. Before servicing, reduce system pressure to zero or isolate the pressure reducing valve from the system. Leave drain valve open. Allow system to cool below 100°F. Failure to follow these instructions could result in serious personal injury or death and property damage.

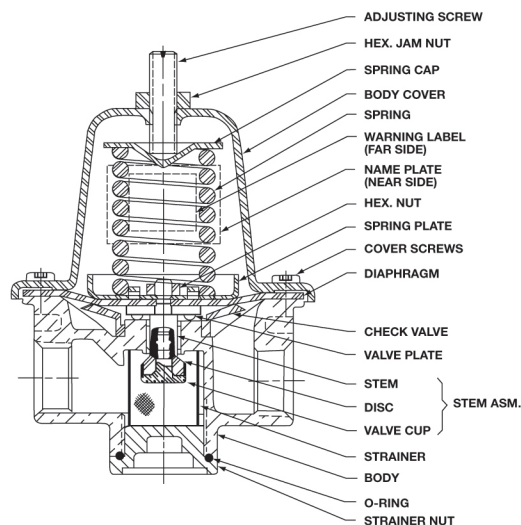

- Remove strainer nut located on bottom of the reducing valve.
- Remove and clean or replace the strainer.
- Reinstall or replace the strainer nut with O-ring into the reducing valve and tighten to a torque of 10 in.-lbs. Min. – 100 in.-lbs. Max. Replace the strainer nut with O-ring if it is damaged.

**WARNING:** Do not use PTFE tape when installing the strainer nut with O-ring. The PTFE tape provides lubricity which can lead to overtightening and breakage. **Do not overtighten.** Failure to follow these instructions can result in moderate personal injury from hot water and/or property damage.

- Close the boiler drain and open cold water shutoff valve to refill system.
- After system has been filled and vented, turn the boiler on-off switch to the “ON” position and resume normal boiler operation. Close the cold water shutoff valve.

**WARNING:** Corrosion or leakage are indications that the Dual Unit reducing valve may be about to cause serious damage from leakage or rupture. It must be periodically inspected and if corrosion or leakage is noted, the Dual Unit reducing valve must be serviced or replaced. Failure to follow these instructions could result in serious personal injury or death and property damage.

To service the valve using the repair kit, follow the first three steps as outlined under Service Instructions and these additional steps:

- Remove the strainer.
- Using a size 25 Torx screwdriver, unfasten the six cover screws and remove the body cover. (A 1/8" Allen wrench will work in an emergency, but stripping may occur).

6. Remove the spring cap and spring.
7. Remove the hex nut by holding the stem assembly stationary while turning the nut counterclockwise. The stem assembly may drop once the nut has been removed.
8. Lift off the spring plate, diaphragm and valve plate.
9. Pull the rubber check valve from the valve body and replace.
10. Insert new stem assembly into valve body through the strainer opening in the housing. Hold in place.
11. Place the new valve plate, knob side down, on the stem assembly.
12. Set new diaphragm on top of stem, aligning holes with those in the body.
13. Place spring plate over the diaphragm on top of the stem assembly.
14. Thread the hex nut on the stem assembly. A dab of Loctite must be added to the hex nut before threading on the stem.

**IMPORTANT:** Any more than a dab will seize the valve.

15. Place spring, spring cap and body cover on top.
16. Align body cover holes with those in the body and fasten body cover screws.
17. Reinstall or replace the strainer nut with O-ring into the reducing valve and tighten to a torque of 10 in.-lbs. Min. – 100 in.-lbs. Max.

**WARNING:** Do not use PTFE tape when installing the strainer nut with O-ring. The PTFE tape provides lubricity which can lead to overtightening and breakage. **Do not overtighten.** Failure to follow these instructions can result in moderate personal injury from hot water and/or property damage.

18. Close the boiler drain and open cold water shutoff valve to refill system.
19. After system has been filled and vented, turn the boiler on/off switch to the “ON” position and resume normal boiler operation. If pressure setting differs from previous setting, refer to section on pressure setting. Close cold water shutoff valve.

#### DUAL UNIT RELIEF VALVE

1. Every 30 days the relief valve is in operation, or after any prolonged period of inactivity, the operating condition of the relief valve should be checked as follows:

**NOTE: To assure continued quality performance, use only genuine Bell & Gossett replacement parts.**

**WARNING:** The uncontrolled discharge of hot water from the relief valve can be very hazardous and could scald anyone in the vicinity. Make sure that proper discharge piping is in place at all times. Failure to follow these instructions could result in serious personal injury or death and property damage.

- a. Shut off the circulating pump and the fuel input to the boiler. Allow system to cool to below 100°F.
- b. Isolate the boiler from the system by closing shutoff valves. Leave the expansion tank valve and the automatic fill valve open.
- c. Lift the manual opening lever on top of the relief valve to the full open position and hold it open for at least five seconds or until clean water is discharged.
- d. Release the lever and allow the relief valve to snap closed. If the relief valve leaks, operate the manual opening lever several more times to clear the seat of any foreign material that is preventing proper seating.
- e. If the relief valve continues to leak, it must be replaced before the boiler is returned to operation.

**WARNING:** Scale buildup from the continuous discharge of the relief valve will prevent the relief valve from discharging its rated capacity, should an over pressurization condition occur. Immediately shut down the boiler and replace the relief valve should this condition occur. Failure to follow these instructions could result in serious personal injury or death and property damage.

- f. After it has been determined that the relief valve is not leaking, return the system to operation by reversing the steps in a. and b. above.
2. When the above test is performed, also inspect the safety relief valve for signs of corrosion, damage, or scale buildup. Inspect and make sure the discharge line is clear.

**WARNING:** Corrosion, scale buildup, leakage or damage to the relief valve are indications the relief valve may fail to provide over pressurization protection. Every 30 days the relief valve must be inspected and if any of the above conditions are noted it must be replaced. Failure to follow these instructions could result in serious personal injury or death and property damage.



Xylem Inc.  
8200 N. Austin Avenue  
Morton Grove, Illinois 60053  
Phone: (847) 966-3700  
Fax: (847) 965-8379  
[www.xyleminc.com/brands/bellgossett](http://www.xyleminc.com/brands/bellgossett)